

# A Guide to Stormwater Best Management Practices





## INTRODUCTION

Construction sites should be managed to minimize the pollution that can leave the site with storm water. Taking appropriate measures to reduce erosion, remove sediment, and manage construction materials and equipment will minimize storm water pollution.

**Reducing soil erosion** is a crucial aspect of storm water pollution prevention for construction sites. Reducing erosion is easier and less expensive than attempting to remove sediment from the storm water.

Contributions to an *increase* in erosion are:

- Removing vegetation
- Exposing sub-soil to weathering
- Exposing sub-soil to vehicle traffic
- Re-shaping the land
- Allowing gullies to form and grow
- Longer/Steeper slopes

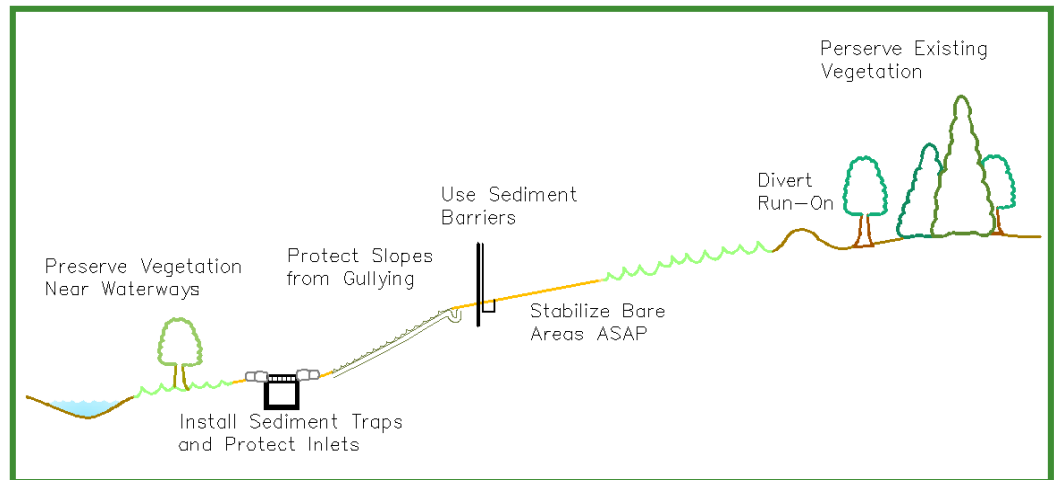

Steps must be taken to *minimize* these factors of erosion during and after construction.

**Removing the sediment** that does get into the storm water is also important to protect the storm drain system and waterways.

**Managing construction material and equipment** for pollution is important for any construction site, including building construction sites. There must be means for safe disposal of all types of waste. The tracking and washing of soil into the street must be prevented. Downstream storm water inlets should also be protected.

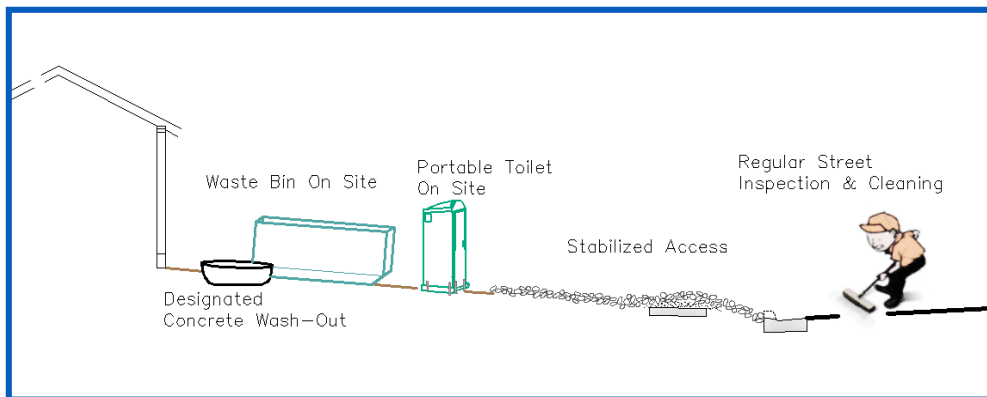

**Regular inspection and proper maintenance** of the site will help ensure the effectiveness of the BMPs in minimizing storm water pollution.

This manual includes Best Management Practices (BMPs) that are useful for reducing pollutants leaving construction sites, particularly those that may be discharged into the storm water systems. Implementing these measures is important because the water from the storm drain systems drains directly into the streams, usually untreated, then through the wetlands before entering the Great Salt Lake. Construction sites can be a significant source of pollution to the streams and wetlands, which can damage them and be detrimental to their role in our environment.

Not all possible BMPs are available from this menu. If you would like to use a BMP that is not included here, propose it to your local jurisdiction.





# CONSTRUCTION

## Best Management Practices

### INDEX

		Waste and Material Management	Vehicle and Equipment Management	Stabilization	Runoff Diversion	Velocity Reduction	Sediment Removal
BE	Benching				✓		
BRF	Brush or Rock Filter						✓
BRRC	Building Repair, Remodeling, and Construction	✓					
CD	Check Dams				✓		
CESA	Contaminated or Erodible Surface Area			✓			
CM	Chemical Mulch			✓			
CP	Compaction			✓			
CR	Construction Road Stabilization			✓			
CST	Curb Sedimentation Trap						✓
CWM	Concrete Waste Management	✓					
DC	Dust Controls			✓			
DD	Diversion Dikes				✓		
DI	Drainage Isolation				✓		
EBB	Earth Berm Barrier	✓					
ECB	Erosion Control Blankets			✓			
EVWA	Equipment and Vehicle Washdown Area		✓				
FR	Fiber Rolls						✓
FS	Filter Strips			✓			
GM	Geotextiles and Mats			✓			
HM	Hydromulching			✓			
HWM	Hazardous Waste Management	✓					
IP-E	Inlet Protection - Excavated						✓
IP-GB	Inlet Protection - Gravel Bags						✓
IP-SB	Inlet Protection - Silt Bags						✓
IP-SF	Inlet Protection - Silt Fence or Straw Bale						✓
MS	Material Storage	✓					
MU	Mulching			✓			
OP	Outlet Protection					✓	
PEV	Preservation of Existing Vegetation			✓			
PT	Portable Toilet	✓					
SB	Sediment Basin						✓
SBB	Sand Bag Barrier						✓
SCE	Stabilized Construction Entrance			✓			
SCU	Spill Clean-Up	✓					
SD	Slope Drain				✓		
SF	Silt Fence						✓
SP	Seeding and Planting			✓			
SR	Surface Roughening					✓	
SS	Street Sweeping						✓
ST	Sediment Trap						✓
STB	Straw Bale Barrier						✓
TDS	Temporary Drains or Swales				✓		
TPS	Temporary and Permanent Seeding			✓			
TSC	Temporary Stream Crossing				✓		
VEC	Vehicle and Equipment Cleaning		✓				
VEF	Vehicle and Equipment Fueling		✓				
WD	Waste Disposal	✓					

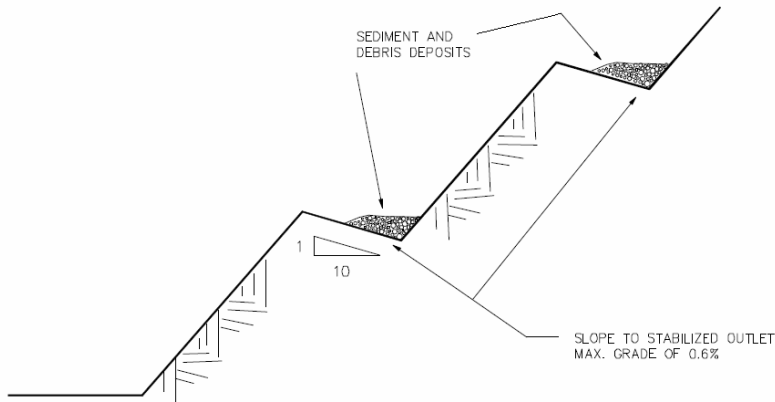

**OBJECTIVES**

- Housekeeping Practices
- Contain Waste
- Minimize Disturbed Areas
- Stabilize Disturbed Areas
- Protect Slopes/Channels
- Control Site Perimeter
- Control Internal Erosion

**TARGETED POLLUTANTS**

**H M L**

- Sediment
- Nutrients
- Heavy Metals
- Toxic Materials
- Oil & Grease
- Floatable Materials
- Bacteria & Viruses
- Other Waste

**IMPLEMENTATION REQUIREMENTS**

**H M L**

- Capital Costs
- O&M Costs
- Maintenance
- Training
- Staffing
- Administrative

**H = High M = Medium L = Low**

**DESCRIPTION:**

Slope construction with benches spaced at regular intervals perpendicular to the slope which intercept and collect sheet flow and direct it to a stable outfall point.

**APPLICATION:**

- Unstabilized cut and fill slopes
- Large stockpiles
- Existing unstable slopes

**INSTALLATION / APPLICATION CRITERIA:**

- Benches should be formed as slope is constructed and graded to the outlet point
- Stabilized outlet with sediment controls should be in place prior to slope construction

**LIMITATIONS:**

- Construction slope design must accommodate benching
- Not appropriate for sandy or rocky soil
- Only effective if suitable outlet provided

**MAINTENANCE:**

- Inspect after major storm events and at least biannually; repair damaged areas
- Remove debris blocking water flow
- Inspect outlet, repair/replace sediment controls and remove sediment build up



1500 East 650 North  
Fruit Heights, UT 84037

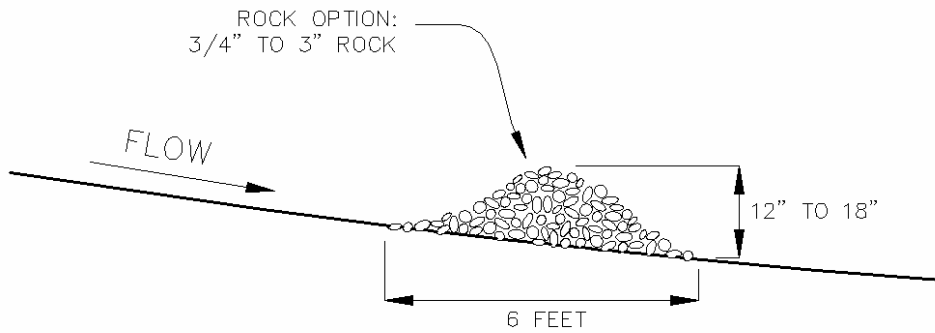

**OBJECTIVES**

- Housekeeping Practices
- Contain Waste
- Minimize Disturbed Areas
- Stabilize Disturbed Areas
- Protect Slopes/Channels
- Control Site Perimeter
- Control Internal Erosion

**TARGETED POLLUTANTS**

**H M L**

- Sediment
- Nutrients
- Heavy Metals
- Toxic Materials
- Oil & Grease
- Floatable Materials
- Bacteria & Viruses
- Other Waste

**IMPLEMENTATION REQUIREMENTS**

**H M L**

- Capital Costs
- O&M Costs
- Maintenance
- Training
- Staffing
- Administrative

**H = High M = Medium L = Low**

**DESCRIPTION:**

A rock filter is made of rock 3/4" - 3" in diameter and placed along a level contour. A brush filter is composed of brush (usually obtained during the site clearing) wrapped in filter cloth and anchored to the toe of the slope. If properly anchored brush or rock filters may be used for sediment trapping and velocity reduction.

**APPLICATION:**

- As check dams across mildly sloped construction roads
- Below the toe of slopes
- Along the site perimeter
- In areas where sheet flow occurs
- Around temporary spoil areas
- At sediment traps or culvert/pipe outlets

**INSTALLATION / APPLICATION CRITERIA:**

- For rock filter, use larger rock and place in a staked, woven wire sheathing if placed where concentrated flows occur
- Install along a level contour
- Leave area behind berm where runoff can pond and sediment can settle
- Drainage areas should not exceed 5 acres

**LIMITATIONS:**

- Rock berms may be difficult to remove
- Removal problems limit their usefulness in landscaped areas
- Runoff will pond upstream of the filter, possibly causing flooding if sufficient space does not exist

**MAINTENANCE:**

- Inspect after each rainfall and at a minimum of once every two weeks
- If berm is damaged, reshape and replace lost/dislodged rock
- Remove sediment when depth reaches 1/3 of berm height or 1 ft



1500 East 650 North  
Fruit Heights, UT 84037

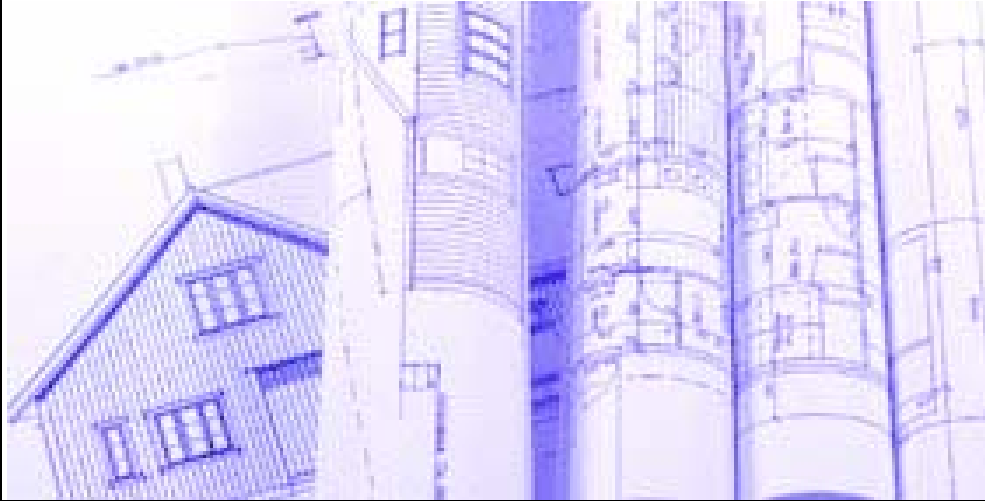

**OBJECTIVES**

- Housekeeping Practices
- Contain Waste
- Minimize Disturbed Areas
- Stabilize Disturbed Areas
- Protect Slopes/Channels
- Control Site Perimeter
- Control Internal Erosion

**TARGETED POLLUTANTS**

**H M L**

- Sediment
- Nutrients
- Heavy Metals
- Toxic Materials
- Oil & Grease
- Floatable Materials
- Bacteria & Viruses
- Other Waste

**IMPLEMENTATION REQUIREMENTS**

**H M L**

- Capital Costs
- O&M Costs
- Maintenance
- Training
- Staffing
- Administrative

**H = High M = Medium L = Low**

**DESCRIPTION:**

Prevent or reduce the discharge of pollutants to storm water from building repair, remodeling and construction by using soil erosion controls, enclosing or covering building material storage areas, using good housekeeping practices, using safer alternative products, and training employees.

**APPLICATION:**

- Use soil erosion control techniques if bare ground is temporarily exposed
- Use permanent soil erosion control techniques if the remodeling clears buildings from an area that are not to be replaced

**INSTALLATION / APPLICATION CRITERIA:**

- Enclose painting operations consistent with local air quality regulations and OSHA
- Properly store materials that are normally used in repair and remodeling such as paints and solvents
- Properly store and dispose waste materials generated from the activity
- Maintain good housekeeping practices while work is underway

**LIMITATIONS:**

- This BMP is for minor construction only
- Hazardous waste that cannot be re-used or recycled must be disposed of by a licensed hazardous waste hauler
- Safer alternative products may not be available, suitable, or effective in every case
- Be certain that actions to help storm water quality are consistent with OSHA and air quality regulations

**MAINTENANCE:**

None



1500 East 650 North  
Fruit Heights, UT 84037

PLAN VIEW

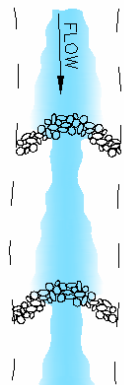

CROSS SECTIONS

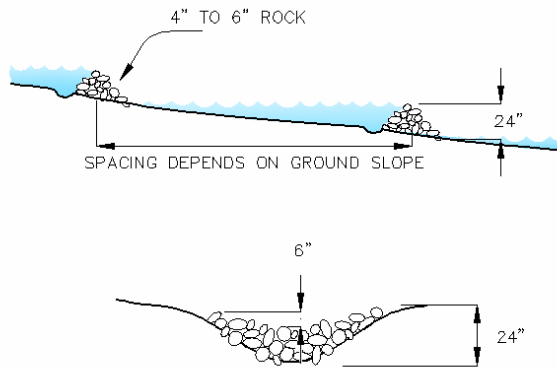

**OBJECTIVES**

- Housekeeping Practices
- Contain Waste
- Minimize Disturbed Areas
- Stabilize Disturbed Areas
- Protect Slopes/Channels
- Control Site Perimeter
- Control Internal Erosion

**TARGETED POLLUTANTS**

**H M L**

- Sediment
- Nutrients
- Heavy Metals
- Toxic Materials
- Oil & Grease
- Floatable Materials
- Bacteria & Viruses
- Other Waste

**DESCRIPTION:**

Small, temporary dams constructed across a drainage ditch to reduce velocity of concentrated storm water flows thereby reducing the erosion of the ditch.

**APPLICATION:**

- Temporary drainage paths
- Permanent drainage ways not yet stabilized
- Existing drainage paths receiving increased flows due to construction

**INSTALLATION / APPLICATION CRITERIA:**

- Prepare location of dam by removing any debris and rough grading any irregularities in channel bottom
- Place rocks by hand or with appropriate machinery; do not dump
- Space dams to make the base of the upstream dam the same elevation as the top of the next lower dam
- Construct dam with center lower to create a weir effect
- Construct 50% side slopes on dams

**LIMITATIONS:**

- Maximum recommended drainage area is 10 acres
- Maximum recommended height is 24"
- Do not use in running stream

**MAINTENANCE:**

- Inspect dams daily during prolonged rainfall after each major rain event and at a minimum of once every two weeks
- Remove any large debris and repair any damage to dam, channel or sideslopes
- Remove accumulated sediment when it reaches one half the height of the dam

**IMPLEMENTATION REQUIREMENTS**

**H M L**

- Capital Costs
- O&M Costs
- Maintenance
- Training
- Staffing
- Administrative

H = High M = Medium L = Low



1500 East 650 North  
Fruit Heights, UT 84037

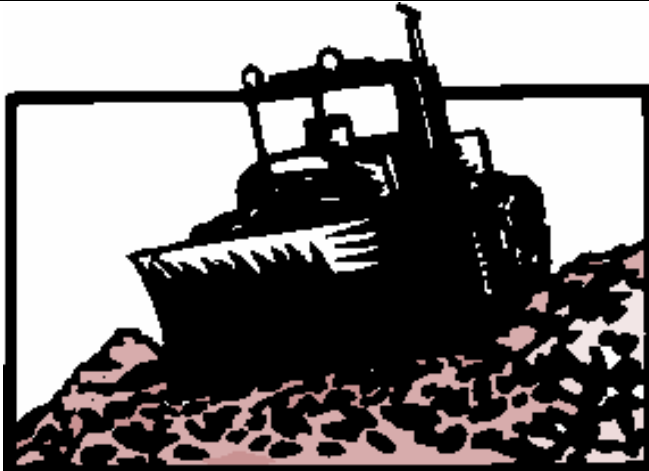

**OBJECTIVES**

- Housekeeping Practices
- Contain Waste
- Minimize Disturbed Areas
- Stabilize Disturbed Areas
- Protect Slopes/Channels
- Control Site Perimeter
- Control Internal Erosion

**TARGETED POLLUTANTS**

**H M L**

- Sediment
- Nutrients
- Heavy Metals
- Toxic Materials
- Oil & Grease
- Floatable Materials
- Bacteria & Viruses
- Other Waste

**IMPLEMENTATION REQUIREMENTS**

**H M L**

- Capital Costs
- O&M Costs
- Maintenance
- Training
- Staffing
- Administrative

**H = High M = Medium L = Low**

**DESCRIPTION:**

Prevent or reduce the discharge of pollutants to storm water from contaminated or erodible surface areas by leaving as much vegetation on-site as possible, minimizing soil exposure time, stabilizing exposed soils, and preventing storm water runoff and runoff.

**APPLICATION:**

This BMP addresses soils which are not so contaminated as to exceed criteria but the soil is eroding and carrying pollutants off in the storm water.

**INSTALLATION / APPLICATION CRITERIA:**

Contaminated or erodible surface areas can be controlled by:

- Preservation of natural vegetation, revegetation, chemical stabilization, removal of contaminated soils or geosynthetics.

**LIMITATIONS:**

Disadvantages of preserving natural vegetation or re-vegetating include:

- Requires substantial planning to preserve and maintain the existing vegetation.
- May not be cost-effective with high land costs.
- Lack of rainfall and/or poor soils may limit the success of re-vegetated areas.

Disadvantages of chemical stabilization include:

- Creation of impervious surfaces.
- May cause harmful effects on water quality.
- Is usually more expensive than vegetative cover.

**MAINTENANCE:**

Maintenance should be minimal, except possibly if irrigation of vegetation is necessary.



1500 East 650 North  
Fruit Heights, UT 84037



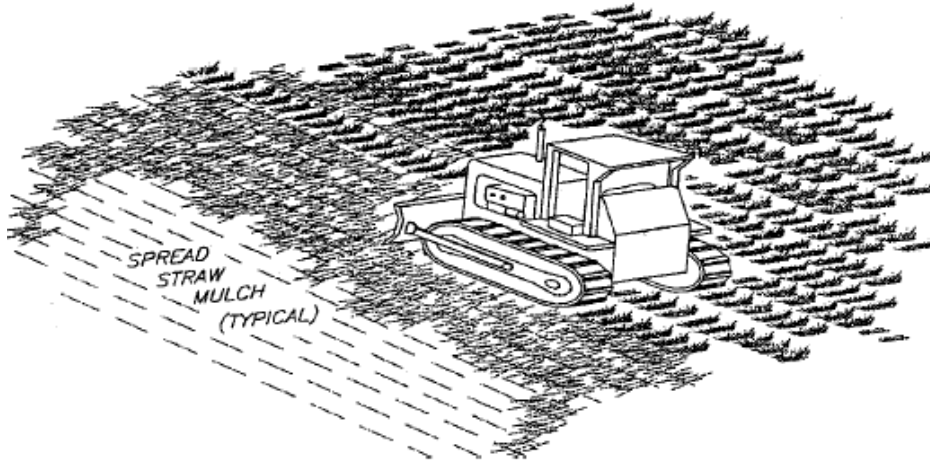

**DESCRIPTION:**

Applying materials such as vinyl, asphalt, plastics, or rubber on an unprotected slope to temporarily stabilize the slope.

**APPLICATION:**

- As a tacking agent to aid the stabilization of mulches (where matting is not used)
- As a short-term alternative in areas where temporary seeding practices cannot be used because of seasonal condition or climate
- On steep and rocky slopes where neither mechanical methods or mulches and protective netting can be effectively applied

**INSTALLATION / APPLICATION CRITERIA:**

- The application rates and procedures recommended by the manufacturer of a chemical stabilization product should be followed to prevent the products from forming ponds and from creating large areas where moisture cannot get through.
- For permanent application, chemical mulches (when used with seed and mulch) should be applied over wood fiber or straw mulch

**LIMITATIONS:**

- Chemical mulches can create impervious surfaces and impact water quality if not properly applied
- Some products may not be suitable for use near live streams

**MAINTENANCE:**

- Inspect at regular intervals and after each runoff-producing storm event or at a minimum of once every two weeks
- Replace chemical mulch as needed to ensure adequate level of coverage

**OBJECTIVES**

- Housekeeping Practices
- Contain Waste
- Minimize Disturbed Areas
- Stabilize Disturbed Areas
- Protect Slopes/Channels
- Control Site Perimeter
- Control Internal Erosion

**TARGETED POLLUTANTS**

**H M L**

- Sediment
- Nutrients
- Heavy Metals
- Toxic Materials
- Oil & Grease
- Floatable Materials
- Bacteria & Viruses
- Other Waste

**IMPLEMENTATION REQUIREMENTS**

**H M L**

- Capital Costs
- O&M Costs
- Maintenance
- Training
- Staffing
- Administrative

**H = High M = Medium L = Low**



1500 East 650 North  
Fruit Heights, UT 84037

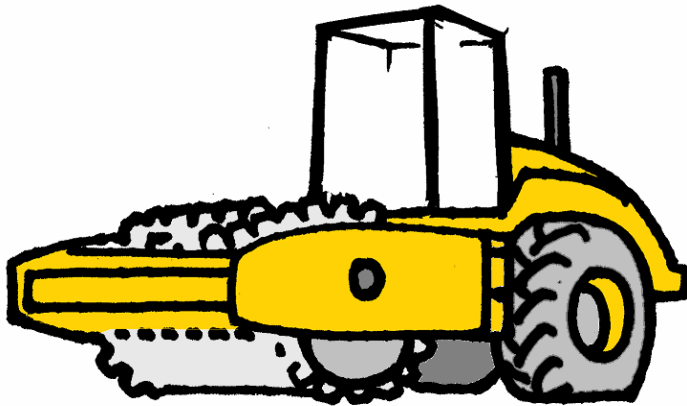

**OBJECTIVES**

- Housekeeping Practices
- Contain Waste
- Minimize Disturbed Areas
- Stabilize Disturbed Areas
- Protect Slopes/Channels
- Control Site Perimeter
- Control Internal Erosion

**TARGETED POLLUTANTS**

**H M L**

- Sediment
- Nutrients
- Heavy Metals
- Toxic Materials
- Oil & Grease
- Floatable Materials
- Bacteria & Viruses
- Other Waste

**IMPLEMENTATION REQUIREMENTS**

**H M L**

- Capital Costs
- O&M Costs
- Maintenance
- Training
- Staffing
- Administrative

**H = High M = Medium L = Low**

**DESCRIPTION:**

Use of rolling, tamping, or vibration to stabilize fill materials and control erosion by increasing the soil density. Increasing the density of soil improves soil strength, reduces long-term soil settlement, and provides resistance to erosion.

**APPLICATIONS:**

- Stabilize fill material placed around various structures.
- Improve soil in place as foundation support for roads, parking lots, and buildings.

**INSTALLATION / APPLICATION CRITERIA:**

- Make sure soil moisture content is at optimum levels.
- Use proper compaction equipment.
- Install sediment control and storm water management devices below compacted areas and runoff interceptor devices above these areas. Drainage from compacted areas must be carefully planned to protect adjacent uncompacted soils.
- The surface of compacted areas should be scarified and seeded or mulched and seeded to increase the effectiveness of compaction.

**LIMITATIONS:**

- Compaction tends to increase runoff.
- Over-compaction will hamper revegetation efforts.

**MAINTENANCE:**

No maintenance required.



1500 East 650 North  
Fruit Heights, UT 84037

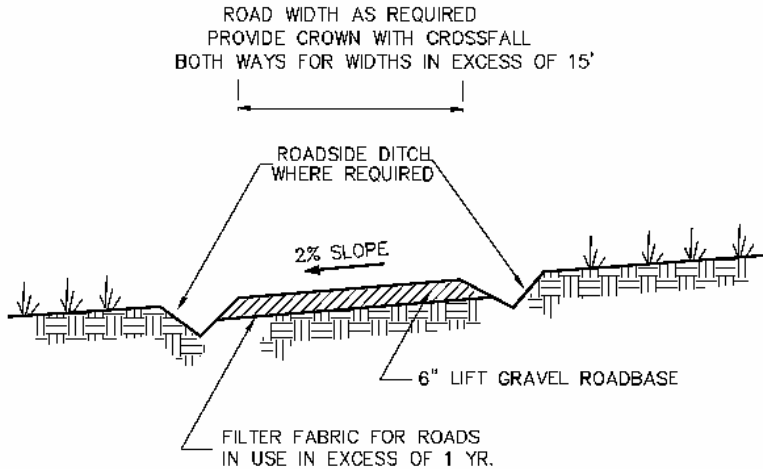

**DESCRIPTION:**

Temporary stabilization of on-site roadway by placement of gravel roadbase.

**APPLICATION:**

- On-site roadways used daily by construction traffic (may not apply to gravelly type soils)
- Parking or staging areas susceptible to erosion due to traffic use

**INSTALLATION / APPLICATION CRITERIA:**

- Grade temporary access road with 2% cross fall, for two-way width provide crown
- Provide roadside ditch and outlet controls where required
- Place 6 inches of 2-inch to 4-inch crushed rock on driving area

**LIMITATIONS:**

- May require removal of gravel roadbase at completion of activities if final cover is not impervious
- May require controls for surface storm water runoff

**MAINTENANCE:**

- Inspect after major rainfall events and at a minimum of once every two weeks
- Place additional gravel as needed and repair any damaged areas
- Maintain any roadside drainage controls

**OBJECTIVES**

- Housekeeping Practices
- Contain Waste
- Minimize Disturbed Areas
- Stabilize Disturbed Areas
- Protect Slopes/Channels
- Control Site Perimeter
- Control Internal Erosion

**TARGETED POLLUTANTS**

**H M L**

- Sediment
- Nutrients
- Heavy Metals
- Toxic Materials
- Oil & Grease
- Floatable Materials
- Bacteria & Viruses
- Other Waste

**IMPLEMENTATION REQUIREMENTS**

**H M L**

- Capital Costs
- O&M Costs
- Maintenance
- Training
- Staffing
- Administrative

H = High M = Medium L = Low



1500 East 650 North  
Fruit Heights, UT 84037



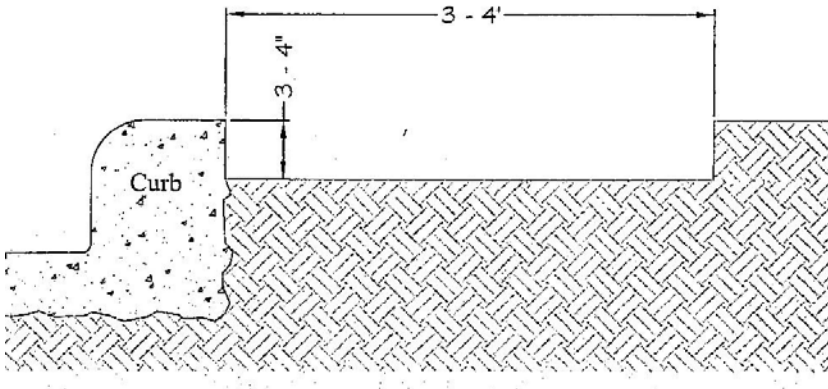

**DESCRIPTION:**

A temporary sediment trap formed by excavation behind the curb.

**APPLICATION:**

- Interception of runoff containing sediment from the lot during construction
- Retain sediment on the lot during construction

**INSTALLATION / APPLICATION CRITERIA:**

- Excavate soil behind the curb to a depth of 3-4 inches
- Extend excavation 3-4 feet behind the curb to form sediment trap

**LIMITATIONS:**

No limitations

**MAINTENANCE:**

- Inspect after each rainfall event and at a minimum of once every two weeks
- Remove accumulated sediment as it reaches 2/3 height of available storage
- May require additional excavation if dirt from construction fills in the trap

**OBJECTIVES**

- Housekeeping Practices
- Contain Waste
- Minimize Disturbed Areas
- Stabilize Disturbed Areas
- Protect Slopes/Channels
- Control Site Perimeter
- Control Internal Erosion

**TARGETED POLLUTANTS**

**H M L**

- Sediment
- Nutrients
- Heavy Metals
- Toxic Materials
- Oil & Grease
- Floatable Materials
- Bacteria & Viruses
- Other Waste

**IMPLEMENTATION REQUIREMENTS**

**H M L**

- Capital Costs
- O&M Costs
- Maintenance
- Training
- Staffing
- Administrative

H = High M = Medium L = Low



1500 East 650 North  
Fruit Heights, UT 84037

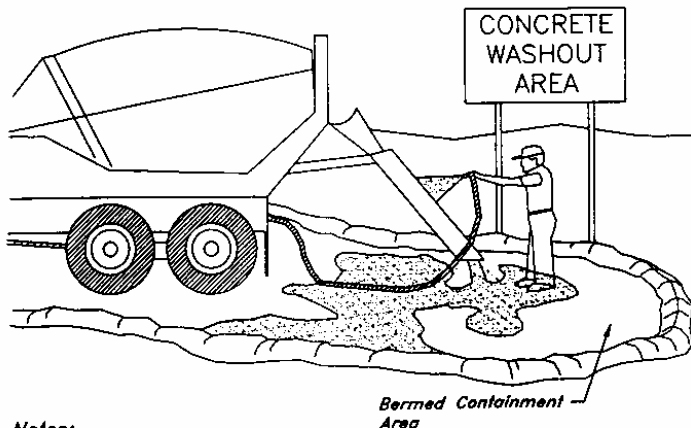

**DESCRIPTION:**

Prevent or reduce the discharge of pollutants to storm water from concrete waste by conducting washout off-site, performing on-site washout in a designated area, and training employees and subcontractors.

**APPLICATION:**

This technique is applicable to all types of sites

**INSTALLATION / APPLICATION CRITERIA:**

- Store dry materials under cover, away from drainage areas
- Minimize excess mixing of fresh concrete, mortar or cement on site
- Do not wash out concrete trucks into storm drains, open ditches, streets, or streams
- Do not allow excess concrete to be dumped on-site, except in designated areas
- When washing concrete to remove fine particles and expose the aggregate, avoid creating runoff by draining the water within a bermed or level area (6" tall X 6' wide)
- Train employees and subcontractors in proper concrete waste management

**LIMITATIONS:**

- Off-site washout or concrete wastes may not always be possible

**MAINTENANCE:**

- Inspect subcontractors to ensure that concrete wastes are being properly managed
- If using a temporary pit, dispose of hardened concrete on a regular basis

**OBJECTIVES**

- Housekeeping Practices
- Contain Waste
- Minimize Disturbed Areas
- Stabilize Disturbed Areas
- Protect Slopes/Channels
- Control Site Perimeter
- Control Internal Erosion

**TARGETED POLLUTANTS**

**H M L**

- Sediment
- Nutrients
- Heavy Metals
- Toxic Materials
- Oil & Grease
- Floatable Materials
- Bacteria & Viruses
- Other Waste

**IMPLEMENTATION REQUIREMENTS**

**H M L**

- Capital Costs
- O&M Costs
- Maintenance
- Training
- Staffing
- Administrative

H = High M = Medium L = Low



1500 East 650 North  
Fruit Heights, UT 84037

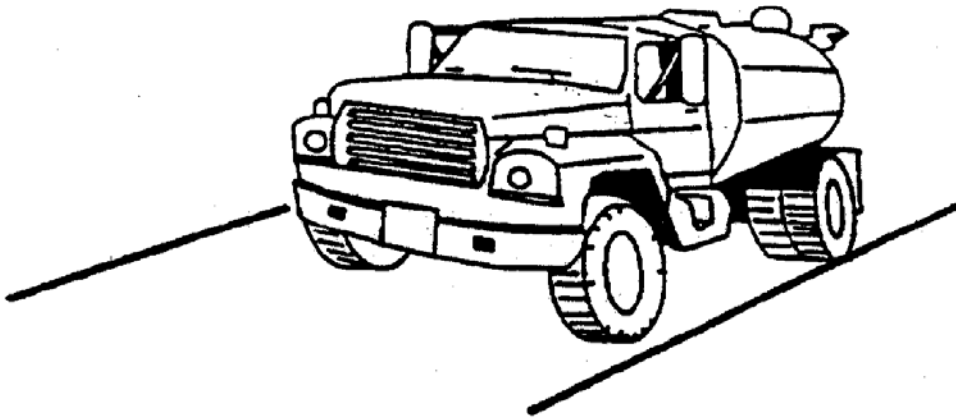

**OBJECTIVES**

- Housekeeping Practices
- Contain Waste
- Minimize Disturbed Areas
- Stabilize Disturbed Areas
- Protect Slopes/Channels
- Control Site Perimeter
- Control Internal Erosion

**TARGETED POLLUTANTS**

**H M L**

- Sediment
- Nutrients
- Heavy Metals
- Toxic Materials
- Oil & Grease
- Floatable Materials
- Bacteria & Viruses
- Other Waste

**IMPLEMENTATION REQUIREMENTS**

**H M L**

- Capital Costs
- O&M Costs
- Maintenance
- Training
- Staffing
- Administrative

**H = High M = Medium L = Low**

**DESCRIPTION:**

Dust control measures are used to stabilize soil from wind erosion, and reduce dust by construction activities.

**APPLICATION:**

Dust control is useful in any process area, loading and unloading area, material handling areas, and transfer areas where dust is generated. Street sweepers are limited to areas that are paved.

**INSTALLATION / APPLICATION CRITERIA:**

- Mechanical dust collection systems are designed according to the size of dust particles and the amount of air to be processed. Manufacturers' recommendations should be followed for installation (as well as the design of the equipment).
- Two kinds of street sweepers are common: brush and vacuum. Vacuum sweepers are more efficient and work best when the area is dry.
- Mechanical equipment should be operated according to the manufacturers' recommendations and should be inspected regularly.

**LIMITATIONS:**

- More elaborate equipment may be impossible to maintain by plant personnel
- Is labor and equipment intensive and may not be effective for all pollutants (street sweepers)

**MAINTENANCE:**

If water sprayers are used, dust-contaminated waters should be collected and taken for treatment. Areas will probably need to be resprayed to keep dust from spreading.



1500 East 650 North  
Fruit Heights, UT 84037



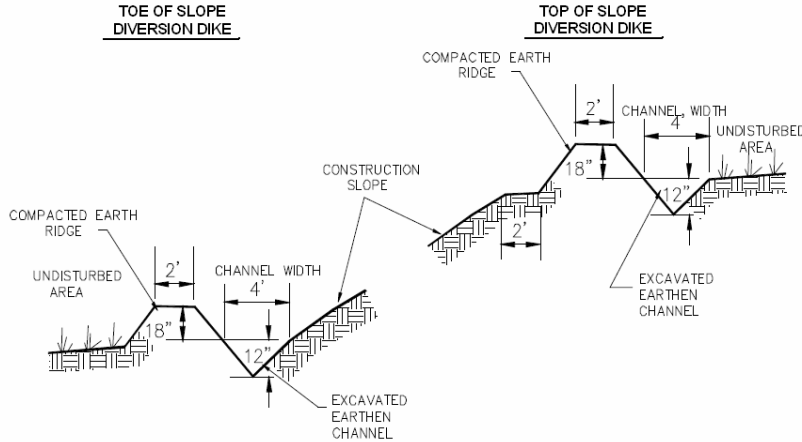

**OBJECTIVES**

- Housekeeping Practices
- Contain Waste
- Minimize Disturbed Areas
- Stabilize Disturbed Areas
- Protect Slopes/Channels
- Control Site Perimeter
- Control Internal Erosion

**TARGETED POLLUTANTS**

**H M L**

- Sediment
- Nutrients
- Heavy Metals
- Toxic Materials
- Oil & Grease
- Floatable Materials
- Bacteria & Viruses
- Other Waste

**IMPLEMENTATION REQUIREMENTS**

**H M L**

- Capital Costs
- O&M Costs
- Maintenance
- Training
- Staffing
- Administrative

**H = High M = Medium L = Low**

**DESCRIPTION:**

A temporary sediment barrier and storm runoff conveyance consisting of an excavation channel and compacted earth ridge.

**APPLICATION:**

- Construct along top of construction slope to intercept upgradient runoff and convey around construction site
- Construct along toe of construction to divert sediment laden runoff
- Construct along midpoint of construction slope to intercept runoff and channel to controlled discharge point
- Construct around base of soil stockpiles to capture sediment
- Construct around perimeter of disturbed areas to capture sediment

**INSTALLATION / APPLICATION CRITERIA:**

- Clear and grub area for dike construction
- Excavate channel and place soil on downgradient side
- Shape and machine compact excavated soil to form ridge
- Place erosion protection (riprap, mulch) at outlet
- Stabilize channel and ridge as required with mulch, gravel, or vegetative cover

**LIMITATIONS:**

- Recommended maximum drainage area of 5 acres
- Recommended maximum sideslopes of 2h:1v (50%)
- Recommended maximum slope of 1% on channel

**MAINTENANCE:**

- Inspect immediately after any rainfall and at least daily during prolonged rainfall
- Look for runoff breaching dike or eroding channel or sideslopes
- Check discharge point for erosion or bypassing of flows
- Repair and stabilize as necessary
- Inspect daily during vehicular activity on slope, check for and repair any traffic damage



1500 East 650 North  
Fruit Heights, UT 84037

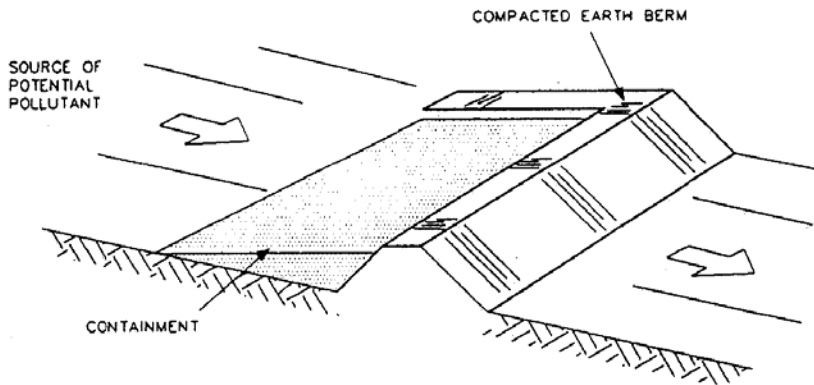

**OBJECTIVES**

- Housekeeping Practices
- Contain Waste
- Minimize Disturbed Areas
- Stabilize Disturbed Areas
- Protect Slopes/Channels
- Control Site Perimeter
- Control Internal Erosion

**TARGETED POLLUTANTS**

**H M L**

- Sediment
- Nutrients
- Heavy Metals
- Toxic Materials
- Oil & Grease
- Floatable Materials
- Bacteria & Viruses
- Other Waste

**IMPLEMENTATION REQUIREMENTS**

**H M L**

- Capital Costs
- O&M Costs
- Maintenance
- Training
- Staffing
- Administrative

**H = High M = Medium L = Low**

**DESCRIPTION:**

A temporary containment control constructed of compacted soil.

**APPLICATION:**

- Construct around waste and materials storage area
- Construct around staging and maintenance areas
- Construct around vehicle parking and servicing areas

**INSTALLATION / APPLICATION CRITERIA:**

- Construct an earthen berm down hill of the area to be controlled. The berm should surround fueling facilities and maintenance areas on three sides to provide containment
- Berm needs to sized for application and be compacted by compactor equipment

**LIMITATIONS:**

- Not effective on steep slopes
- Limits access to controlled area
- Personnel need to quickly respond to spills with remedial actions

**MAINTENANCE:**

- Observe daily for any non-stormwater discharge
- Look for runoff bypassing ends of berms or undercutting berms
- Repair or replace damaged areas of the berm and remove accumulated sediment
- Recompact soil around berm as necessary to prevent piping



1500 East 650 North  
Fruit Heights, UT 84037

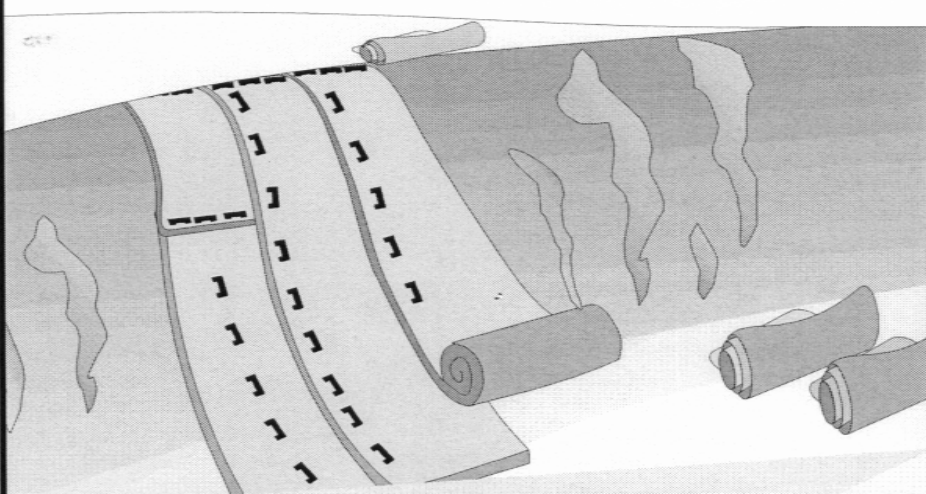

**DESCRIPTION:**

Erosion control blankets are used on areas of high velocity runoff and/or steep grade, to aid in controlling erosion on critical areas by protecting young vegetation.

**APPLICATION:**

- Where vegetation is likely to grow too slowly to provide adequate stabilization
- In areas subject to high winds where mulch would not be effective

**INSTALLATION / APPLICATION CRITERIA:**

- Install erosion control blankets parallel to the direction of the slope
- In ditches, apply in direction of the flow
- Place erosion control blankets loosely on soil-do not stretch
- Ends of blankets should be buried no less than six inches deep
- Staple the edges of the blanket at least every three feet - per manufacturers' specifications

**LIMITATIONS:**

- Not recommended in areas which are still under construction

**MAINTENANCE:**

- Check for erosion and undermining periodically, particularly after rainstorms
- Repair dislocations or failures immediately
- If washouts occur, reinstall after repairing slope damage
- Monitor until permanently stabilized

**OBJECTIVES**

- Housekeeping Practices
- Contain Waste
- Minimize Disturbed Areas
- Stabilize Disturbed Areas
- Protect Slopes/Channels
- Control Site Perimeter
- Control Internal Erosion

**TARGETED POLLUTANTS**

**H M L**

- Sediment
- Nutrients
- Heavy Metals
- Toxic Materials
- Oil & Grease
- Floatable Materials
- Bacteria & Viruses
- Other Waste

**IMPLEMENTATION REQUIREMENTS**

**H M L**

- Capital Costs
- O&M Costs
- Maintenance
- Training
- Staffing
- Administrative

**H = High M = Medium L = Low**



1500 East 650 North  
Fruit Heights, UT 84037



# BMP: Equipment and Vehicle Wash Down Area

EVWA

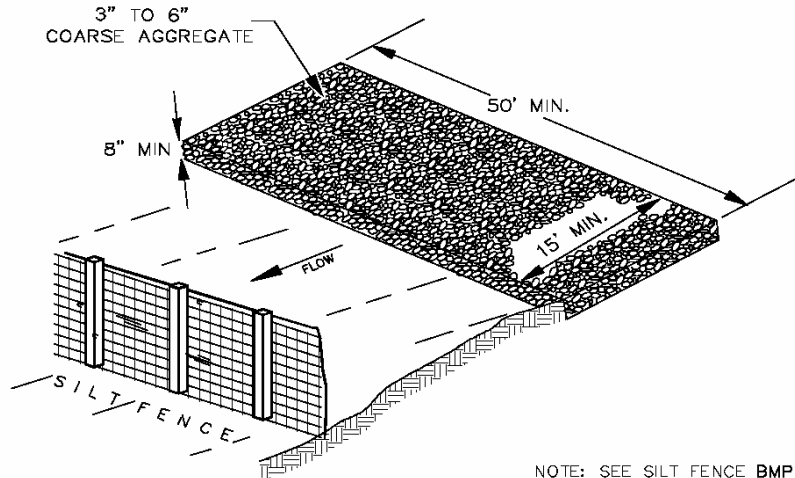

NOTE: SEE SILT FENCE BMP SHEET

## DESCRIPTION:

A stabilized pad of crushed stone for general washing of equipment and construction vehicles.

## APPLICATION:

At any site where regular washing of vehicles and equipment will occur. May also be used as a filling point for water trucks limiting erosion caused by overflow or spillage of water.

## INSTALLATION / APPLICATION CRITERIA:

- Clear and grub area and grade to provide maximum slope of 1%
- Compact subgrade and place filter fabric if desired (recommended for wash areas to remain in use for more than 3 months)
- Place coarse aggregate, 1 to 2-1/2 inches in size, to a minimum depth of 8 inches
- Install silt fence downgradient (see silt fence BMP information sheet)

## LIMITATIONS:

Cannot be utilized for washing equipment or vehicles that may cause contamination of runoff such as fertilizer equipment or concrete equipment. Solely used to control sediment in wash water.

## MAINTENANCE:

- Inspect daily for loss of gravel or sediment buildup
- Inspect adjacent area for sediment deposit and install additional controls as necessary
- Repair area and replace gravel as required to maintain control in good working condition
- Expand stabilized area as required to accommodate activities
- Maintain silt fence as outlined in specific silt fence BMP information sheet

## OBJECTIVES

- Housekeeping Practices
- Contain Waste
- Minimize Disturbed Areas
- Stabilize Disturbed Areas
- Protect Slopes/Channels
- Control Site Perimeter
- Control Internal Erosion

## TARGETED POLLUTANTS

### H M L

- Sediment
- Nutrients
- Heavy Metals
- Toxic Materials
- Oil & Grease
- Floatable Materials
- Bacteria & Viruses
- Other Waste

## IMPLEMENTATION REQUIREMENTS

### H M L

- Capital Costs
- O&M Costs
- Maintenance
- Training
- Staffing
- Administrative

H = High M = Medium L = Low



1500 East 650 North  
Fruit Heights, UT 84037

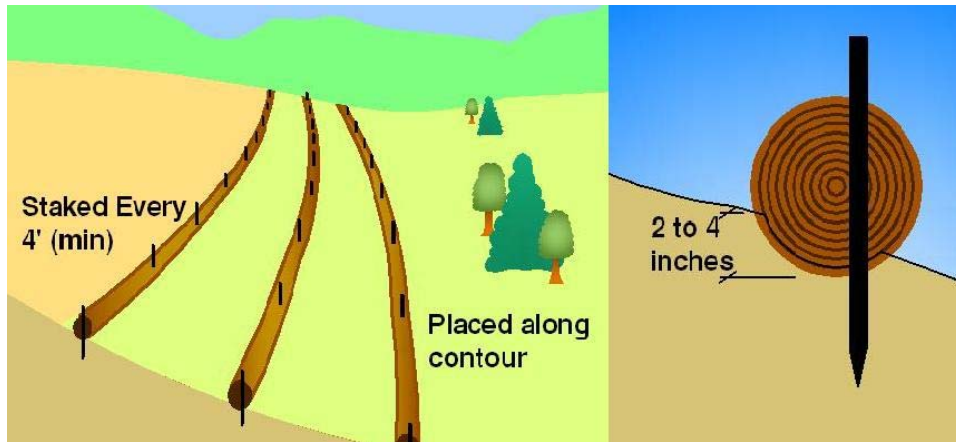

**OBJECTIVES**

- Housekeeping Practices
- Contain Waste
- Minimize Disturbed Areas
- Stabilize Disturbed Areas
- Protect Slopes/Channels
- Control Site Perimeter
- Control Internal Erosion

**TARGETED POLLUTANTS**

**H M L**

- Sediment
- Nutrients
- Heavy Metals
- Toxic Materials
- Oil & Grease
- Floatable Materials
- Bacteria & Viruses
- Other Waste

**IMPLEMENTATION REQUIREMENTS**

**H M L**

- Capital Costs
- O&M Costs
- Maintenance
- Training
- Staffing
- Administrative

**H = High M = Medium L = Low**

**DESCRIPTION:**

Commercial products can be made from various types of fibers and shavings that are rolled up and used as sediment barriers.

**APPLICATION:**

- Good for sites with long slopes, generally flatter than 10:1

**INSTALLATION / APPLICATION CRITERIA:**

- Must be trenched into the ground 2 to 4 inches
- Must be staked every 4 feet (maximum)
- Manufacturer's instructions must be followed for installation of product

**LIMITATIONS:**

- Not applicable for high velocity flows
- Only use for a time period within the expected life-span of the product (check with manufacturer)

**MAINTENANCE:**

- Must be checked to ensure that runoff does not run under or bypass the fiber rolls
- Sediment buildup must also be checked and excess sediment must be removed



1500 East 650 North  
Fruit Heights, UT 84037

# BMP: Filter Strips

FS

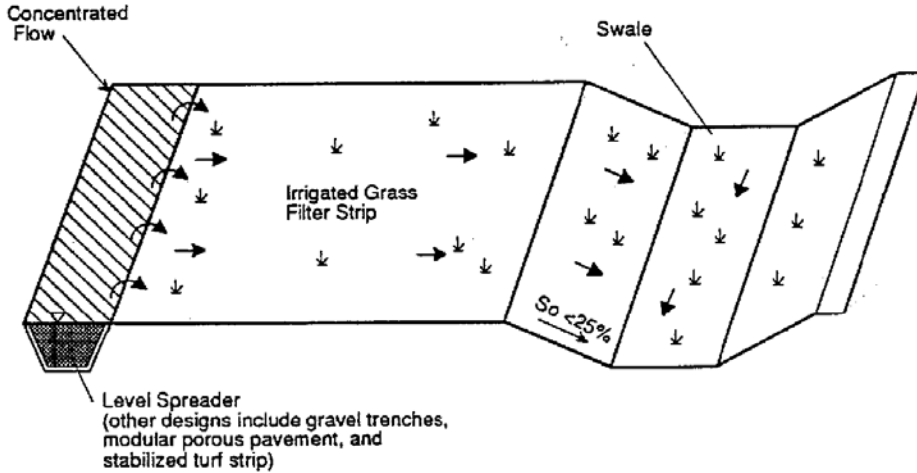

## OBJECTIVES

- Housekeeping Practices
- Contain Waste
- Minimize Disturbed Areas
- Stabilize Disturbed Areas
- Protect Slopes/Channels
- Control Site Perimeter
- Control Internal Erosion

## TARGETED POLLUTANTS

### H M L

- Sediment
- Nutrients
- Heavy Metals
- Toxic Materials
- Oil & Grease
- Floatable Materials
- Bacteria & Viruses
- Other Waste

## DESCRIPTION:

Filter strips are 20-foot-wide strips of natural or planted vegetation around a construction site. They are designed to cause deposition of sediments within the vegetation layer.

## APPLICATION:

- Suited for areas where the soils are well drained or moderately well drained
- Areas where the bedrock and the water table are well below the surface

## INSTALLATION / APPLICATION CRITERIA:

- Make sure the vegetative cover is dense enough to protect underlying soil while causing sediment to settle
- Filter strip must be approximately 20 feet wide to function well
- The length should be approximately 50 to 75 feet. Where slopes become steeper the length of the strip must be increased.

## LIMITATIONS:

- Only applicable in areas where vegetation is previously established or where sod is added
- Vegetated filter strips will not function well on steep slopes, in hilly areas, or in highly paved areas
- Sites with slopes of 15 percent or more may not be suitable for filtering storm water flows

## MAINTENANCE:

- Check for channels and repair
- Provide rock aprons to aid in slowing flow if necessary
- Maintain vegetation at optimal height and thickness

## IMPLEMENTATION REQUIREMENTS

### H M L

- Capital Costs
- O&M Costs
- Maintenance
- Training
- Staffing
- Administrative

H = High M = Medium L = Low



1500 East 650 North  
Fruit Heights, UT 84037



FLOW RATES VARY ACCORDING TO MANUFACTURER

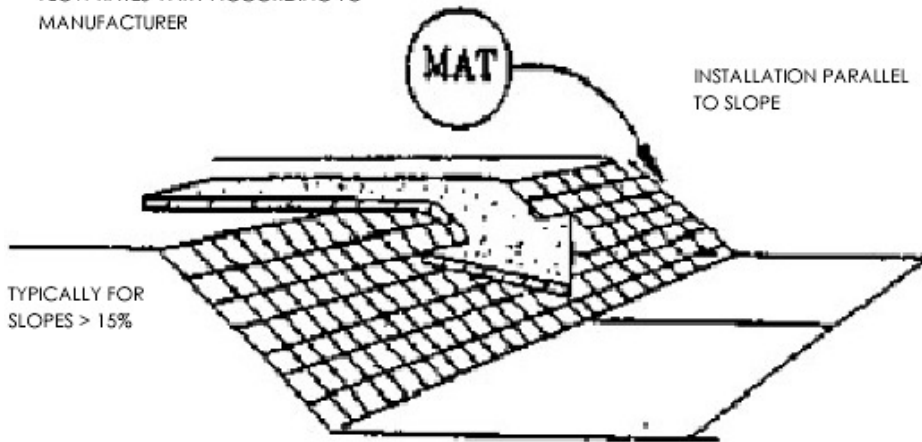

**OBJECTIVES**

- Housekeeping Practices
- Contain Waste
- Minimize Disturbed Areas
- Stabilize Disturbed Areas
- Protect Slopes/Channels
- Control Site Perimeter
- Control Internal Erosion

**TARGETED POLLUTANTS**

**H M L**

- Sediment
- Nutrients
- Heavy Metals
- Toxic Materials
- Oil & Grease
- Floatable Materials
- Bacteria & Viruses
- Other Waste

**DESCRIPTION:**

Mattings made of natural or synthetic material which are used to temporarily or permanently stabilize soil.

**APPLICATION:**

- Typically suited for post-construction site stabilization, but may be used for stabilization of highly erosive soils.
- Channels and Streams.
- Steep slopes.

**INSTALLATION / APPLICATION CRITERIA:**

- Mattings may be applied to disturbed soils and where existing vegetation has been removed.
- The following organic matting materials provide temporary protection until permanent vegetation is established, or when seasonal circumstances dictate the need for temporary stabilization until weather or construction delays are resolved: Jute mattings and straw mattings.
- The following synthetic mattings may be used for either temporary or post-construction stabilization, both with and without vegetation: excelsior matting, glass fiber matting, mulch matting
- Staples are needed to anchor the matting.

**LIMITATIONS:**

- Mattings are more costly than other BMP practices, limiting their use to areas where other BMPs are ineffective (e.g., channels, steep slopes).
- May delay seed germination, due to reduction in soil temperature.
- Installation requires experienced contractor to ensure soil stabilization and erosion protection.

**MAINTENANCE:**

- Inspect twice monthly and after significant rainfall.
- Re-anchor loosened matting and replace missing matting and staples as required.

**IMPLEMENTATION REQUIREMENTS**

**H M L**

- Capital Costs
- O&M Costs
- Maintenance
- Training
- Staffing
- Administrative

**H = High M = Medium L = Low**



1500 East 650 North  
Fruit Heights, UT 84037



**DESCRIPTION:**

A combination of wood fiber mulch, processed grass, or hay or straw mulch and a tacking agent. It is made into a slurry, then applied to bare slopes or other bare areas to provide temporary stabilization.

**APPLICATION:**

- Small roadside slopes
- Large, relatively flat areas

**INSTALLATION / APPLICATION CRITERIA:**

- Legume seeds should be pellet inoculated with the appropriate bacteria.
- The seed should not remain in the hydromulcher tank for more than 30 minutes
- Wood fiber may be dyed to aid in uniform application
- Slurry should be uniformly applied until an adequate coverage is achieved
- The applicator should not be directed at on location for a long period of time; erosion will occur

**LIMITATIONS:**

- Will lose effectiveness after 1 year
- Can use only on physically stable slopes (at natural angle of repose, or less)

**MAINTENANCE:**

- Periodically inspect for damage caused by wind, water or human disturbance
- Promptly repair damaged areas

**OBJECTIVES**

- Housekeeping Practices
- Contain Waste
- Minimize Disturbed Areas
- Stabilize Disturbed Areas
- Protect Slopes/Channels
- Control Site Perimeter
- Control Internal Erosion

**TARGETED POLLUTANTS**

**H M L**

- Sediment
- Nutrients
- Heavy Metals
- Toxic Materials
- Oil & Grease
- Floatable Materials
- Bacteria & Viruses
- Other Waste

**IMPLEMENTATION REQUIREMENTS**

**H M L**

- Capital Costs
- O&M Costs
- Maintenance
- Training
- Staffing
- Administrative

**H = High M = Medium L = Low**



1500 East 650 North  
Fruit Heights, UT 84037



**DESCRIPTION:**

Prevent or reduce the discharge of pollutants to stormwater from hazardous waste through proper material use, waste disposal, and training of employees and subcontractors.

**APPLICATION:**

Many of the chemicals used on-site can be hazardous materials which become hazardous waste upon disposal. These wastes may include:

- Paints and Solvents; petroleum products such as oils, fuels, and grease; herbicides and pesticides; Acids for cleaning masonry; and concrete curing compounds

In addition, sites with existing structures may contain wastes which must be disposed of in accordance with Federal, State, and local regulations, including:

- Sandblasting grit mixed with lead, cadmium, or chromium-based paints; Asbestos; and PCB's

**INSTALLATION / APPLICATION CRITERIA:**

The following steps will help reduce storm water pollution from hazardous wastes:

- Use all of the product before disposing of the container
- Do not remove the original product label, it contains important safety and disposal information
- Do not over-apply herbicides and pesticides. Prepare only the amount needed. Follow the recommended usage instructions. Apply surface dressings in several smaller applications, as opposed to one large application, to allow time for infiltration and to avoid excess material being carried off-site by runoff. Do not apply these chemicals just before it rains. People applying pesticides must be certified in accordance with Federal and State regulations.

**LIMITATIONS:**

Hazardous waste that cannot be reused or recycled must be disposed of by a licensed hazardous waste hauler.

**MAINTENANCE:**

- Inspect hazardous waste receptacles and area regularly
- Arrange for regular hazardous waste collection

**OBJECTIVES**

- Housekeeping Practices
- Contain Waste
- Minimize Disturbed Areas
- Stabilize Disturbed Areas
- Protect Slopes/Channels
- Control Site Perimeter
- Control Internal Erosion

**TARGETED POLLUTANTS**

**H M L**

- Sediment
- Nutrients
- Heavy Metals
- Toxic Materials
- Oil & Grease
- Floatable Materials
- Bacteria & Viruses
- Other Waste

**IMPLEMENTATION REQUIREMENTS**

**H M L**

- Capital Costs
- O&M Costs
- Maintenance
- Training
- Staffing
- Administrative

**H = High M = Medium L = Low**



1500 East 650 North  
Fruit Heights, UT 84037

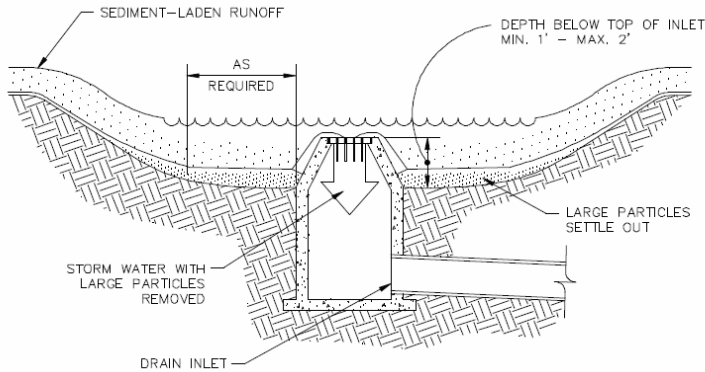

**OBJECTIVES**

- Housekeeping Practices
- Contain Waste
- Minimize Disturbed Areas
- Stabilize Disturbed Areas
- Protect Slopes/Channels
- Control Site Perimeter
- Control Internal Erosion

**TARGETED POLLUTANTS**

**H M L**

- Sediment
- Nutrients
- Heavy Metals
- Toxic Materials
- Oil & Grease
- Floatable Materials
- Bacteria & Viruses
- Other Waste

**IMPLEMENTATION REQUIREMENTS**

**H M L**

- Capital Costs
- O&M Costs
- Maintenance
- Training
- Staffing
- Administrative

**H = High M = Medium L = Low**

**DESCRIPTION:**

An area excavated around a storm drain inlet to impound water below the inlet.

**APPLICATION:**

- Construct at storm drainage inlets located downgradient of areas to be disturbed by construction (for inlets in paved areas see other information sheets for inlet protection)

**INSTALLATION / APPLICATION CRITERIA:**

- Provide upgradient sediment controls, such as silt fence during construction of inlet
- When construction of inlet is complete, excavate adjacent area 1 to 2 feet lower than the grate elevation. Size of excavated area should be based on soil type and contributing acreage

**LIMITATIONS:**

- Recommended maximum contributing drainage area of one acre
- Limited to inlets located in open unpaved areas
- Requires flat area adjacent to inlet

**MAINTENANCE:**

- Inspect inlet protection following storm event and at a minimum of once monthly
- Remove accumulated sediment when it reaches one half of the excavated sump below the grate
- Repair side slopes as required



1500 East 650 North  
Fruit Heights, UT 84037



# BMP: Inlet Protection - Gravel Bags

IP-GB

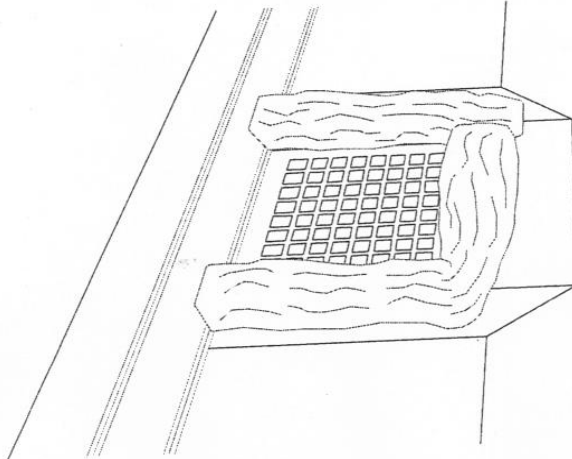

## OBJECTIVES

- Housekeeping Practices
- Contain Waste
- Minimize Disturbed Areas
- Stabilize Disturbed Areas
- Protect Slopes/Channels
- Control Site Perimeter
- Control Internal Erosion

## TARGETED POLLUTANTS

### H M L

- Sediment
- Nutrients
- Heavy Metals
- Toxic Materials
- Oil & Grease
- Floatable Materials
- Bacteria & Viruses
- Other Waste

## IMPLEMENTATION REQUIREMENTS

### H M L

- Capital Costs
- O&M Costs
- Maintenance
- Training
- Staffing
- Administrative

H = High M = Medium L = Low

## DESCRIPTION:

Sediment barrier erected around storm drain inlet.

## APPLICATION:

Construct at storm drainage inlets located down-gradient of areas to be disturbed by construction

## INSTALLATION / APPLICATION CRITERIA:

- Provide up-gradient sediment controls, such as silt fence during construction of inlet
- When construction of curb and gutter and roadway is complete, install gravel filled bags around perimeter of inlet
- Fill to recommended levels to reduce splitting of bags

## LIMITATIONS:

- Recommended maximum contributing drainage area of one acre
- Requires shallow sloped adjacent to inlet.

## MAINTENANCE:

- Inspect inlet protection following storm event and at a minimum of once every 14 days.
- Remove accumulated sediment when it reaches half the height of the bag.
- Look for bypassing or undercutting and repair or realign as needed.
- Replace and clean up spilled gravel when bags split.



1500 East 650 North  
Fruit Heights, UT 84037

# BMP: Inlet Protection- Silt Bags

IP-SB

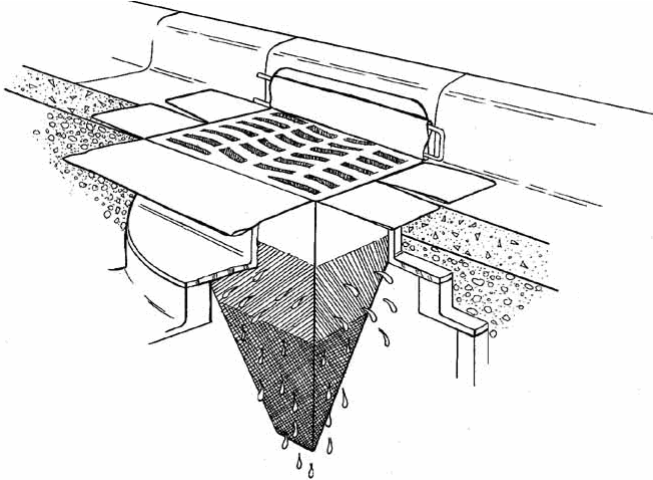

### DESCRIPTION:

Collect and trap sediment and debris entering catch basins from either grated or curb inlets. Insert is made of fabric and is placed in the drain inlet around the perimeter of the grate. Runoff passes through the bag before discharging into the drain outlet pipe. Overflow holes are usually provided to pass larger flows without causing a backwater at the grate. Certain manufactured products include polymers intended to increase pollutant removal effectiveness.

### APPLICATIONS:

- Storm drain inlet boxes

### INSTALLATION / APPLICATION CRITERIA:

- Regular Maintenance is necessary
- Evaluation of the device chosen should be balanced with cost
- Hydraulic capacity controls effectiveness
- Most useful in small drainage areas (< 1 Acre)
- Ideal in combination with other BMP's

### LIMITATIONS:

- Cost
- Maintenance required to prevent plugging and remain effective

### MAINTENANCE:

Inspection after all storm events and as required between events

### OBJECTIVES

- Housekeeping Practices
- Contain Waste
- Minimize Disturbed Areas
- Stabilize Disturbed Areas
- Protect Slopes/Channels
- Control Site Perimeter
- Control Internal Erosion

### TARGETED POLLUTANTS

#### H M L

- Sediment
- Nutrients
- Heavy Metals
- Toxic Materials
- Oil & Grease
- Floatable Materials
- Bacteria & Viruses
- Other Waste

### IMPLEMENTATION REQUIREMENTS

#### H M L

- Capital Costs
- O&M Costs
- Maintenance
- Training
- Staffing
- Administrative

H = High M = Medium L = Low



1500 East 650 North  
Fruit Heights, UT 84037

**STRAW BALE BARRIER**

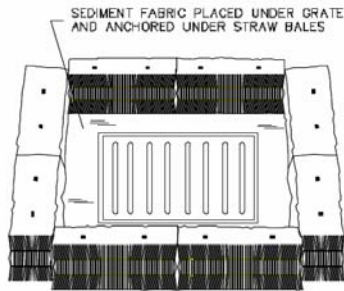

**SILT FENCE**

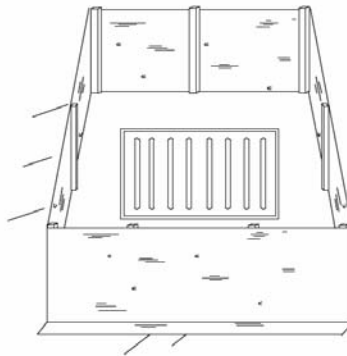

**OBJECTIVES**

- Housekeeping Practices
- Contain Waste
- Minimize Disturbed Areas
- Stabilize Disturbed Areas
- Protect Slopes/Channels
- Control Site Perimeter
- Control Internal Erosion

**TARGETED POLLUTANTS**

**H M L**

- Sediment
- Nutrients
- Heavy Metals
- Toxic Materials
- Oil & Grease
- Floatable Materials
- Bacteria & Viruses
- Other Waste

**IMPLEMENTATION REQUIREMENTS**

**H M L**

- Capital Costs
- O&M Costs
- Maintenance
- Training
- Staffing
- Administrative

**H = High M = Medium L = Low**

**DESCRIPTION:**

Sediment barrier erected around storm drain inlet.

**APPLICATION:**

- Construct at storm drainage inlets located downgradient of areas to be disturbed by construction (for inlets in paved areas see other information sheets for inlet protection)

**INSTALLATION / APPLICATION CRITERIA:**

- Provide upgradient sediment controls, such as silt fence during construction of inlet
- When construction of inlet is complete, erect straw bale barrier or silt fence surrounding perimeter of inlet. Follow instructions and guidelines on individual BMP information sheets for straw bale barrier and silt fence construction

**LIMITATIONS:**

- Recommended maximum contributing drainage area of one acre
- Limited to inlets located in open unpaved areas
- Requires shallow slopes adjacent to inlet

**MAINTENANCE:**

- Inspect inlet protection following storm event and at a minimum of once every two weeks
- Remove accumulated sediment when it reaches 4" in depth
- Repair or realign barrier/fence as needed
- Look for bypassing or undercutting and recompact soil around barrier/fence as required



1500 East 650 North  
Fruit Heights, UT 84037

# BMP: Materials Storage

MS

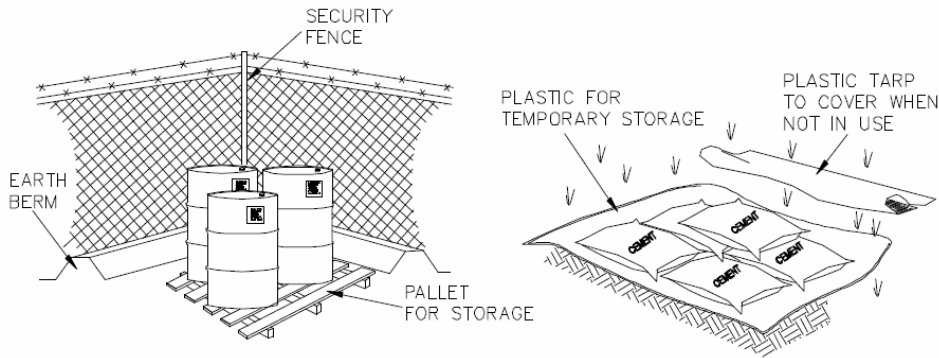

- ▶ CONTROLLED STORAGE LOCATION
- ▶ BARRIER AROUND PERIMETER
- ▶ ELEVATE CONTAINERS OFF GROUND
- ▶ COVER WHEN NOT IN USE

## OBJECTIVES

- Housekeeping Practices
- Contain Waste
- Minimize Disturbed Areas
- Stabilize Disturbed Areas
- Protect Slopes/Channels
- Control Site Perimeter
- Control Internal Erosion

## TARGETED POLLUTANTS

### H M L

- Sediment
- Nutrients
- Heavy Metals
- Toxic Materials
- Oil & Grease
- Floatable Materials
- Bacteria & Viruses
- Other Waste

## DESCRIPTION:

Controlled storage of on-site materials.

## APPLICATION:

- Storage of hazardous, toxic, and all chemical substances
- Any construction site with outside storage of materials

## INSTALLATION / APPLICATION CRITERIA:

- Designate a secured area with limited access as the storage location. Ensure no waterways or drainage paths are nearby
- Construct compacted earthen berm (See Earth Berm Barrier Information Sheet), or similar perimeter containment around storage location for impoundment in the case of spills
- Ensure all on-site personnel utilize designated storage area. Do not store excessive amounts of material that will not be utilized on site
- For active use of materials away from the storage area ensure materials are not set directly on the ground and are covered when not in use. Protect storm drainage during use

## LIMITATIONS:

- Does not prevent contamination due to mishandling of products
- Spill Prevention and Response Plan still required
- Only effective if materials are actively stored in controlled location

## MAINTENANCE:

- Inspect daily and repair any damage to perimeter impoundment or security fencing
- Check materials are being correctly stored (i.e. standing upright, in labeled containers, tightly capped) and that no materials are being stored away from the designated location

## IMPLEMENTATION REQUIREMENTS

### H M L

- Capital Costs
- O&M Costs
- Maintenance
- Training
- Staffing
- Administrative

H = High M = Medium L = Low



1500 East 650 North  
Fruit Heights, UT 84037



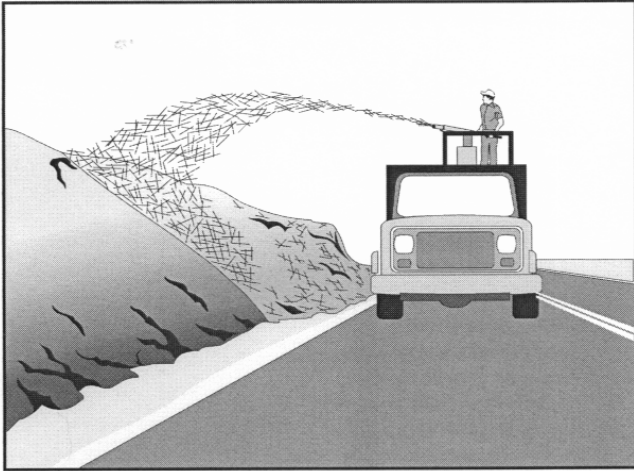

**DESCRIPTION:**

Placement of material such as straw, grass, woodchips, or wood fibers over open areas.

**APPLICATION:**

- Any exposed area to remain untouched longer than 14 days and that will be exposed less than 60 days (seed areas to be exposed in excess of 60 days)
- Areas that have been seeded
- Stockpiled soil materials

**INSTALLATION / APPLICATION CRITERIA:**

- Roughen area to receive mulch to create depressions that mulch material can settle into
- Apply mulch to required thickness and anchor as necessary
- Ensure material used is weed free and does not contain any constituents that will inhibit plant growth

**LIMITATIONS:**

- Anchoring may be required to prevent migration or mulch material
- Downgradient control may be required to prevent mulch material being transported to storm water system

**MAINTENANCE:**

- Inspect mulched areas after every rainfall event and at a minimum of monthly
- Replace mulch on any bare areas and reanchor as necessary
- Clean and replace downgradient controls as necessary

**OBJECTIVES**

- Housekeeping Practices
- Contain Waste
- Minimize Disturbed Areas
- Stabilize Disturbed Areas
- Protect Slopes/Channels
- Control Site Perimeter
- Control Internal Erosion

**TARGETED POLLUTANTS**

**H M L**

- Sediment
- Nutrients
- Heavy Metals
- Toxic Materials
- Oil & Grease
- Floatable Materials
- Bacteria & Viruses
- Other Waste

**IMPLEMENTATION REQUIREMENTS**

**H M L**

- Capital Costs
- O&M Costs
- Maintenance
- Training
- Staffing
- Administrative

**H = High M = Medium L = Low**



1500 East 650 North  
Fruit Heights, UT 84037

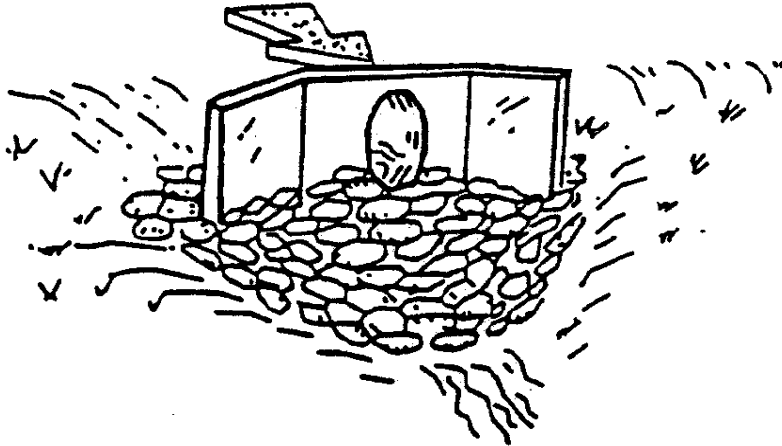

**OBJECTIVES**

- Housekeeping Practices
- Contain Waste
- Minimize Disturbed Areas
- Stabilize Disturbed Areas
- Protect Slopes/Channels
- Control Site Perimeter
- Control Internal Erosion

**TARGETED POLLUTANTS**

**H M L**

- Sediment
- Nutrients
- Heavy Metals
- Toxic Materials
- Oil & Grease
- Floatable Materials
- Bacteria & Viruses
- Other Waste

**IMPLEMENTATION REQUIREMENTS**

**H M L**

- Capital Costs
- O&M Costs
- Maintenance
- Training
- Staffing
- Administrative

**H = High M = Medium L = Low**

**DESCRIPTION:**

A rock outlet protection is a physical device composed of rock, or grouted riprap which is placed at the outlet of a pipe to prevent scour of the soil caused by high pipe flow velocities, and to absorb flow energy to produce nonerosive velocities.

**APPLICATION:**

- Wherever discharge velocities and energies at the outlets of culverts, conduits, or channels are sufficient to erode the next downstream reach
- Rock outlet protection is best suited for temporary use during construction because it is usually less expensive and easier to install than concrete aprons or energy dissipators
- A sediment trap below the pipe outlet is recommended if runoff is sediment laden
- Permanent rock riprap protection should be designed and sized by the engineer as part of the culvert, conduit or channel design
- Grouted riprap should be avoided in areas of freeze and thaw because the grout will break up

**INSTALLATION / APPLICATION CRITERIA:**

- Rock outlet protection is effective when the rock is sized and placed properly. When this is accomplished, rock outlets do much to limit erosion at pipe outlets. Rock size should be increased for high velocity flows. Best results are obtained when sound, durable, angular rock is used.

**LIMITATIONS:**

- Large storms often wash away the rock outlet protection and leave the area susceptible to erosion
- Sediment captured by the rock outlet protection may be difficult to remove without removing the rock
- Outlet protection may negatively impact the channel habitat

**MAINTENANCE:**

- Inspect after each significant rain for erosion and/or disruption of the rock, and repair immediately
- Grouted or wire-tied rock riprap can minimize maintenance requirements



1500 East 650 North  
Fruit Heights, UT 84037

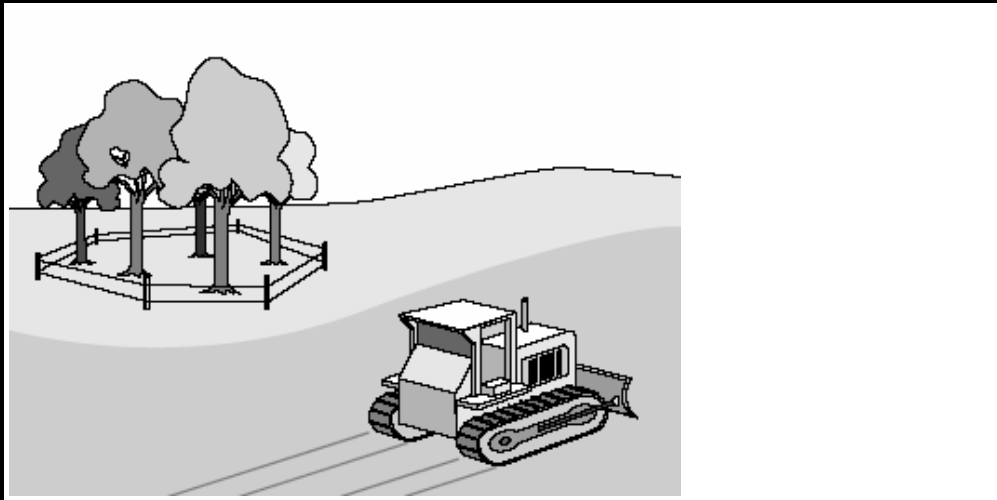

**DESCRIPTION:**

Carefully planned preservation of existing vegetation minimizes the potential of removing or injuring existing trees, vines, shrubs and/or grasses that serve as erosion controls.

**APPLICATION:**

This technique is applicable to all types of sites. Areas where preserving vegetation can be particularly beneficial are floodplains, wetlands, stream banks, steep slopes, and other areas where erosion controls would be difficult to establish, install, or maintain.

**INSTALLATION / APPLICATION CRITERIA:**

- Clearly mark, flag or fence vegetation or areas where vegetation should be preserved.
- Prepare landscaping plans which include as much existing vegetation as possible and state proper care during and after construction.
- Define and protect with berms, fencing, signs, etc. a setback area from vegetation to be preserved.
- Propose landscaping plans which do not include plant species that compete with the existing vegetation.
- Do not locate construction traffic routes, spoil piles, etc. where significant adverse impact on existing vegetation may occur.

**LIMITATIONS:**

- Requires forward planning by the owner/developer, contractor and design staff.
- For sites with diverse topography, it is often difficult and expensive to save existing trees while grading the site satisfactorily for the planned development.
- May not be cost effective with high land costs.

**MAINTENANCE:**

- Inspection and maintenance requirements for protection of vegetation are low.
- Maintenance of native trees or vegetation should conform to landscape plan specifications.

**OBJECTIVES**

- Housekeeping Practices
- Contain Waste
- Minimize Disturbed Areas
- Stabilize Disturbed Areas
- Protect Slopes/Channels
- Control Site Perimeter
- Control Internal Erosion

**TARGETED POLLUTANTS**

**H M L**

- Sediment
- Nutrients
- Heavy Metals
- Toxic Materials
- Oil & Grease
- Floatable Materials
- Bacteria & Viruses
- Other Waste

**IMPLEMENTATION REQUIREMENTS**

**H M L**

- Capital Costs
- O&M Costs
- Maintenance
- Training
- Staffing
- Administrative

**H = High M = Medium L = Low**



1500 East 650 North  
Fruit Heights, UT 84037

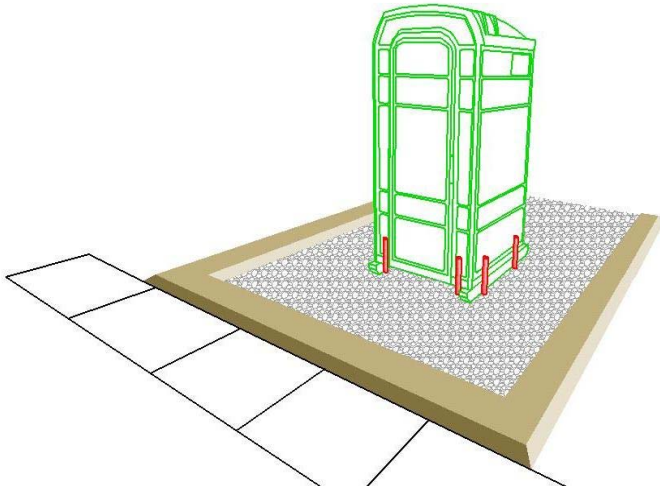

**OBJECTIVES**

- Housekeeping Practices
- Contain Waste
- Minimize Disturbed Areas
- Stabilize Disturbed Areas
- Protect Slopes/Channels
- Control Site Perimeter
- Control Internal Erosion

**TARGETED POLLUTANTS**

**H M L**

- Sediment
- Nutrients
- Heavy Metals
- Toxic Materials
- Oil & Grease
- Floatable Materials
- Bacteria & Viruses
- Other Waste

**IMPLEMENTATION REQUIREMENTS**

**H M L**

- Capital Costs
- O&M Costs
- Maintenance
- Training
- Staffing
- Administrative

**H = High M = Medium L = Low**

**DESCRIPTION:**

Temporary on-site sanitary facilities for construction personnel.

**APPLICATION:**

All sites with no permanent sanitary facilities or where permanent facility is too far from activities.

**INSTALLATION / APPLICATION CRITERIA:**

- Locate portable toilets in a convenient locations throughout the site
- Prepare level, gravel surface and provide clear access to the toilets for servicing and for on-site personnel
- Construct earth berm perimeter (see Earth Berm Barrier Sheet), control for spill / leak protection.
- Anchor the portable toilet to prevent tipping

**LIMITATIONS:**

No limitations

**MAINTENANCE:**

- Portable toilets should be maintained in good working order by licensed service with daily observation for leak detection
- Regular waste collection should be arranged with licensed service
- All waste should be deposited in sanitary sewer system for treatment with appropriate agency approval



1500 East 650 North  
Fruit Heights, UT 84037



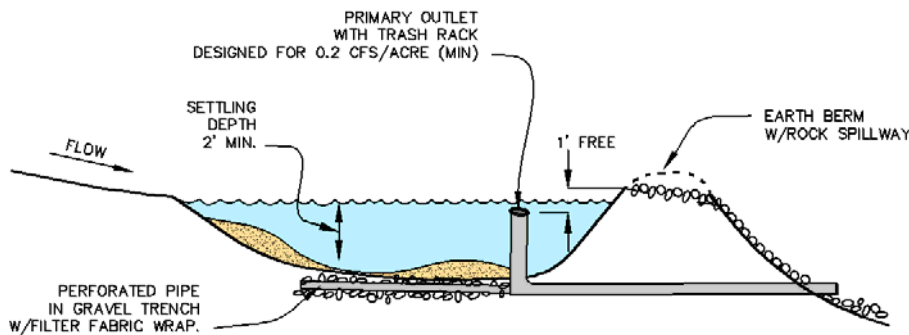

**OBJECTIVES**

- Housekeeping Practices
- Contain Waste
- Minimize Disturbed Areas
- Stabilize Disturbed Areas
- Protect Slopes/Channels
- Control Site Perimeter
- Control Internal Erosion

**TARGETED POLLUTANTS**

**H M L**

- Sediment
- Nutrients
- Heavy Metals
- Toxic Materials
- Oil & Grease
- Floatable Materials
- Bacteria & Viruses
- Other Waste

**IMPLEMENTATION REQUIREMENTS**

**H M L**

- Capital Costs
- O&M Costs
- Maintenance
- Training
- Staffing
- Administrative

**H = High M = Medium L = Low**

**DESCRIPTION:**

A pond created by excavating or construction of an embankment, and designed to retain or detain runoff sufficiently to allow excessive sediment to settle.

**APPLICATION:**

- At the outlet of all disturbed watersheds 10 acres or larger
- At the outlet of smaller disturbed watersheds, as necessary
- Where post construction detention basins will be located

**INSTALLATION / APPLICATION CRITERIA:**

- Design basin for site specific location, maintain effective flow length 2 times width
- Excavate basin or construct compacted berm containment; ensure no downgradient hazard if failure should occur. (Provide minimum of 67 cy. per acre of drainage area.)
- Construct dewatering and outfall structure and emergency spillway with apron

**LIMITATIONS:**

- Should be sized based on anticipated runoff, sediment loading and drainage area size
- May require silt fence at outlet for entrapment of very fine silts and clays
- May require safety fencing to prevent public access
- Height restrictions for embankment regulated by Utah Division of Dam Safety

**MAINTENANCE:**

- Inspect after each rainfall event and at a minimum of once every two weeks
- Repair any damage to berm, spillway or sidewalls
- Remove accumulated sediment as it reaches 2/3 height of available storage
- Check outlet for sedimentation/erosion of downgradient area and remediate as necessary. Install silt fence if sedimentation apparent



1500 East 650 North  
Fruit Heights, UT 84037

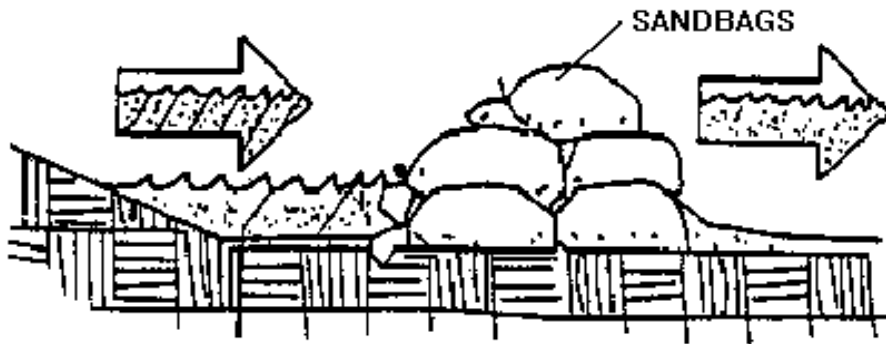

**OBJECTIVES**

- Housekeeping Practices
- Contain Waste
- Minimize Disturbed Areas
- Stabilize Disturbed Areas
- Protect Slopes/Channels
- Control Site Perimeter
- Control Internal Erosion

**TARGETED POLLUTANTS**

**H M L**

- Sediment
- Nutrients
- Heavy Metals
- Toxic Materials
- Oil & Grease
- Floatable Materials
- Bacteria & Viruses
- Other Waste

**IMPLEMENTATION REQUIREMENTS**

**H M L**

- Capital Costs
- O&M Costs
- Maintenance
- Training
- Staffing
- Administrative

**H = High M = Medium L = Low**

**DESCRIPTION:**

Stacking sand bags along a level contour creates a barrier which detains sediment - laden water, ponding water upstream of the barrier and promoting sedimentation

**APPLICATION:**

- Along the perimeter of the site
- May be used in drainage areas up to 5 acres
- Along streams and channels
- Across swales with small catchments
- Around temporary spoil areas
- Below the toe of a cleared slope

**INSTALLATION / APPLICATION CRITERIA:**

- Install along a level contour
- Base of sand bag barrier should be at least 48" wide
- Height of sand bag barrier should be at least 18" high
- 4" PVC pipe may be installed between the top layer of sand bags to drain large flood flows
- Provide area behind barrier for runoff to pond and sediment to settle
- Place below the toe of a slope
- UV resistant bags should be used

**LIMITATIONS:**

- Sand bags are more expensive than other barriers, but also more durable
- Burlap should not be used

**MAINTENANCE:**

- Inspect after each rain and a minimum of once every two weeks
- Reshape or replace damaged sand bags immediately
- Remove buildup of sediment



1500 East 650 North  
Fruit Heights, UT 84037

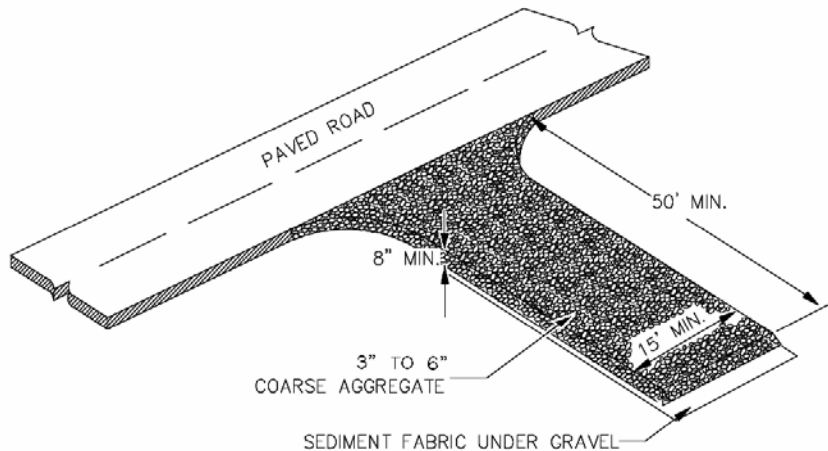

**OBJECTIVES**

- Housekeeping Practices
- Contain Waste
- Minimize Disturbed Areas
- Stabilize Disturbed Areas
- Protect Slopes/Channels
- Control Site Perimeter
- Control Internal Erosion

**TARGETED POLLUTANTS**

**H M L**

- Sediment
- Nutrients
- Heavy Metals
- Toxic Materials
- Oil & Grease
- Floatable Materials
- Bacteria & Viruses
- Other Waste

**IMPLEMENTATION REQUIREMENTS**

**H M L**

- Capital Costs
- O&M Costs
- Maintenance
- Training
- Staffing
- Administrative

**H = High M = Medium L = Low**

**DESCRIPTION:**

A stabilized pad of crushed stone located where construction traffic enters or leaves the site from or to paved surface.

**APPLICATION:**

At any point of ingress and egress at a construction site where adjacent traveled way is paved. Generally applies to sites over 2 acres unless special conditions exist.

**INSTALLATION / APPLICATION CRITERIA:**

- Clear and grub area and grade to provide maximum slope of 2%
- Compact subgrade and place filter fabric if desired (recommended for entrances to remain for more than 3 months)
- Place coarse aggregate, 3-6 inches in size, to a minimum depth of 8 inches

**LIMITATIONS:**

- Requires periodic top dressing with additional stones
- Should be used in conjunction with street sweeping on adjacent public right-of-way

**MAINTENANCE:**

- Inspect daily for loss of gravel or sediment buildup
- Inspect adjacent roadway for sediment deposit and clean by sweeping or shoveling
- Repair entrance and replace gravel as required to maintain control in good working condition
- Expand stabilized area as required to accommodate traffic and prevent erosion at driveways



1500 East 650 North  
Fruit Heights, UT 84037

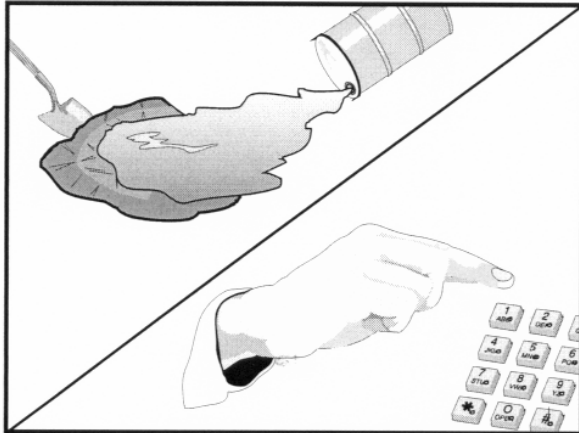

Standard Symbol

- BMP Objectives**
- Soil Stabilization
  - Sediment Control
  - Tracking Control
  - Wind Erosion Control
  - Non-Storm Water Management
  - Materials and Waste Management

**OBJECTIVES**

- Housekeeping Practices
- Contain Waste
- Minimize Disturbed Areas
- Stabilize Disturbed Areas
- Protect Slopes/Channels
- Control Site Perimeter
- Control Internal Erosion

**TARGETED POLLUTANTS**

**H M L**

- Sediment
- Nutrients
- Heavy Metals
- Toxic Materials
- Oil & Grease
- Floatable Materials
- Bacteria & Viruses
- Other Waste

**DESCRIPTION:**

Practices to clean-up leakage/spillage of on-site materials that may be harmful to receiving waters.

**APPLICATION:**

All sites

**GENERAL:**

- Store controlled materials within a storage area
- Educate personnel on prevention and clean-up
- Designate an Emergency Coordinator responsible practices and for providing spill response
- Maintain a supply of clean-up equipment on-site response agencies with phone numbers

**METHODS:**

- Clean-up spills/leaks immediately and remediate cause
- Use as little water as possible. NEVER HOSE DOWN OR BURY SPILL CONTAMINATED MATERIAL
- Use rags or absorbent material for clean-up. Excavate contaminated soils. Dispose of clean-up material and soil as hazardous waste
- Document all spills with date, location, substance, volume, actions taken and other pertinent data.
- Contact local Fire Department and State Division of Environmental Response and Remediation (Phone #536-4100) for any spill of reportable quantity

**IMPLEMENTATION REQUIREMENTS**

**H M L**

- Capital Costs
- O&M Costs
- Maintenance
- Training
- Staffing
- Administrative

H = High M = Medium L = Low



1500 East 650 North  
Fruit Heights, UT 84037



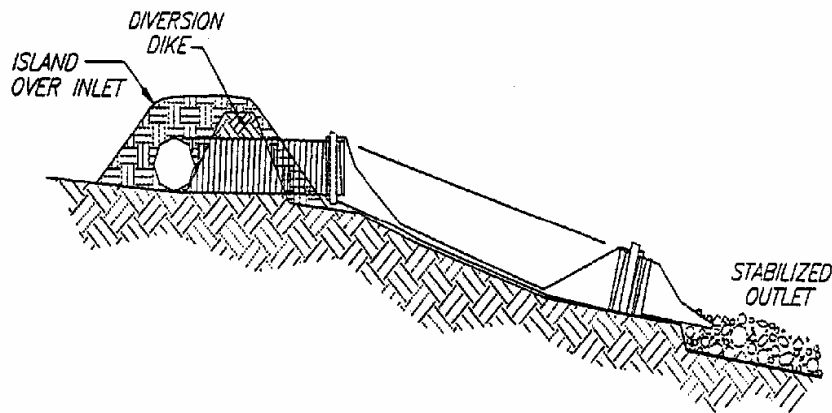

**OBJECTIVES**

- Housekeeping Practices
- Contain Waste
- Minimize Disturbed Areas
- Stabilize Disturbed Areas
- Protect Slopes/Channels
- Control Site Perimeter
- Control Internal Erosion

**TARGETED POLLUTANTS**

**H M L**

- Sediment
- Nutrients
- Heavy Metals
- Toxic Materials
- Oil & Grease
- Floatable Materials
- Bacteria & Viruses
- Other Waste

**IMPLEMENTATION REQUIREMENTS**

**H M L**

- Capital Costs
- O&M Costs
- Maintenance
- Training
- Staffing
- Administrative

**H = High M = Medium L = Low**

**DESCRIPTION:**

A temporary pipe or lined channel that drains the top of a slope to a stable discharge point at the bottom of a slope without causing erosion.

**APPLICATION:**

- Where concentrated flow of surface runoff must be conveyed down a slope in order to prevent erosion
- Emergency spillway for a sediment basin

**INSTALLATION / APPLICATION CRITERIA:**

- Secure inlet and surround with dikes to prevent gully erosion, and anchor pipe to slope
- Size to convey at least the peak of a 10-year storm event
- Stabilize outlet (See Outlet Protection BMP.)

**LIMITATIONS:**

- Maximum drainage area per slope drain is 5 acres
- Clogged slope drains will force water around the pipe and cause slope erosion
- Dissipation of high flow velocities at the pipe outlet is required to avoid downstream erosion
- Failure can result in flooding and severe erosion

**MAINTENANCE:**

- Structure must be inspected weekly and after storms
- Inlet must be protected from undercutting and no water should circumvent the entry
- Outlet should not produce erosion; velocity dissipators must be maintained
- Pipe anchors must be checked to ensure that the pipe remains anchored to the slope



1500 East 650 North  
Fruit Heights, UT 84037

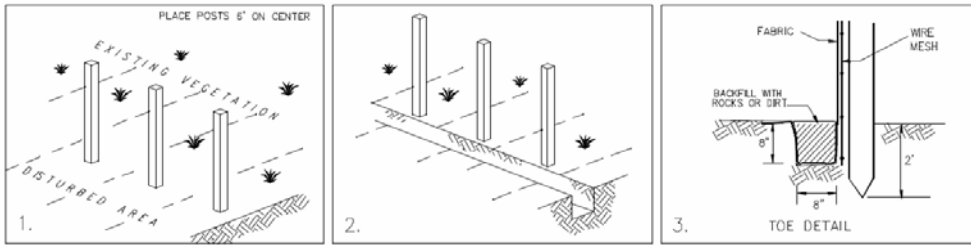

**OBJECTIVES**

- Housekeeping Practices
- Contain Waste
- Minimize Disturbed Areas
- Stabilize Disturbed Areas
- Protect Slopes/Channels
- Control Site Perimeter
- Control Internal Erosion

**TARGETED POLLUTANTS**

**H M L**

- Sediment
- Nutrients
- Heavy Metals
- Toxic Materials
- Oil & Grease
- Floatable Materials
- Bacteria & Viruses
- Other Waste

**IMPLEMENTATION REQUIREMENTS**

**H M L**

- Capital Costs
- O&M Costs
- Maintenance
- Training
- Staffing
- Administrative

**H = High M = Medium L = Low**

**DESCRIPTION:**

A temporary sediment barrier consisting of entrenched filter fabric stretched across and secured to supporting posts.

**APPLICATION:**

- Perimeter control: place barrier at downgradient limits of disturbance
- Sediment barrier: place barrier at toe of slope or soil stockpile
- Protection of existing waterways: place barrier at top of stream bank
- Inlet protection: place fence surrounding catch basins

**INSTALLATION / APPLICATION CRITERIA:**

- Place posts 6' apart on center along contour (or use preassembled unit) and drive 2' minimum into ground. Excavate an anchor trench immediately up gradient of posts
- Cut fabric to require width, unroll along length of barrier and drape over barrier. Secure fabric to mesh with twine, staples, or similar, with trailing edge extending into anchor trench
- Backfill trench over fabric to anchor
- Fabric must have 85% minimum sediment removal efficiency

**LIMITATIONS:**

- Recommended maximum drainage area of 0.5 acre per 100 feet
- Recommended maximum upgradient slope length of 150'
- Recommended maximum uphill grade of 2:1 (50%)
- Recommended maximum flow rate of 0.5 cfs
- Ponding should not be allowed behind fence

**MAINTENANCE:**

- Inspect immediately after any rainfall and at least daily during prolonged rainfall
- Look for runoff bypassing ends of barriers or undercutting barriers
- Repair or replace damaged areas of the barrier and remove accumulated sediment
- Reanchor fence as necessary to prevent shortcutting
- Remove accumulated sediment when it reaches 1/2 the height of the fence



1500 East 650 North  
Fruit Heights, UT 84037

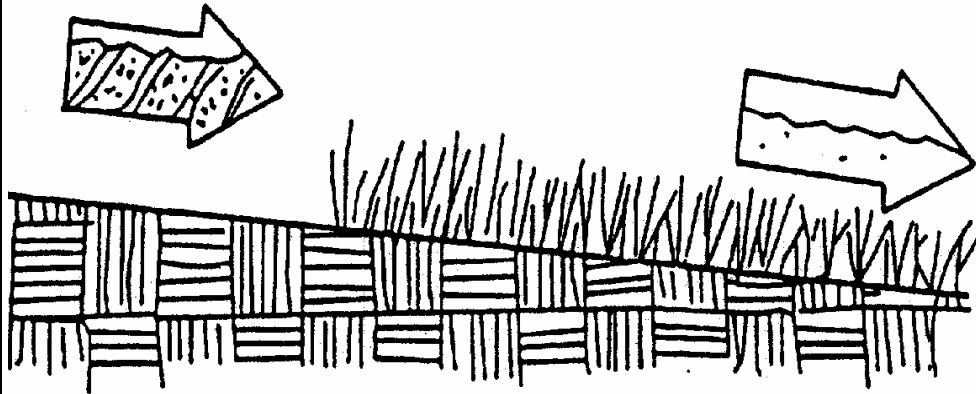

**DESCRIPTION:**

Seeding of grass and plantings of trees, shrubs, vines and ground covers provide long-term stabilization of soil. In some areas, with suitable climates, grasses can be planted for temporary stabilization.

**APPLICATION:**

- Appropriate for site stabilization both during construction and post-construction
- Any graded/cleared areas where construction activities have ceased
- Open space cut and fill areas
- Steep slopes, spoil piles, vegetated swales, landscape corridors, stream banks. Use in conjunction with matting, mulch or blanketing where appropriate.

**INSTALLATION / APPLICATION CRITERIA:**

Type of vegetation, site and seedbed preparation, planting time, fertilization and water requirements should be considered for each application.

**Grasses:**

- Ground preparations: fertilize and mechanically stabilize the soil
- Tolerant of short-term temperature extremes and waterlogged soil composition
- Appropriate soil conditions: shallow soil base, good drainage, slope 2:1 or flatter
- Mowing, irrigating, and fertilizing are vital for promoting vigorous grass growth

**Trees and Shrubs:**

- Selection criteria: vigor, species, size, shape & wildlife food source
- Soil conditions: select species appropriate for soil, drainage & acidity
- Other factors: wind/exposure, temperature extremes, and irrigations needs

**Vines and Ground Covers:**

- Ground preparation: lime and fertilizer preparation
- Use proper seeding rates
- Appropriate soil conditions: drainage, acidity and slopes
- Generally avoid species requiring irrigation

**OBJECTIVES**

- Housekeeping Practices
- Contain Waste
- Minimize Disturbed Areas
- Stabilize Disturbed Areas
- Protect Slopes/Channels
- Control Site Perimeter
- Control Internal Erosion

**TARGETED POLLUTANTS**

**H M L**

- Sediment
- Nutrients
- Heavy Metals
- Toxic Materials
- Oil & Grease
- Floatable Materials
- Bacteria & Viruses
- Other Waste

**IMPLEMENTATION REQUIREMENTS**

**H M L**

- Capital Costs
- O&M Costs
- Maintenance
- Training
- Staffing
- Administrative

**H = High M = Medium L = Low**



1500 East 650 North  
Fruit Heights, UT 84037

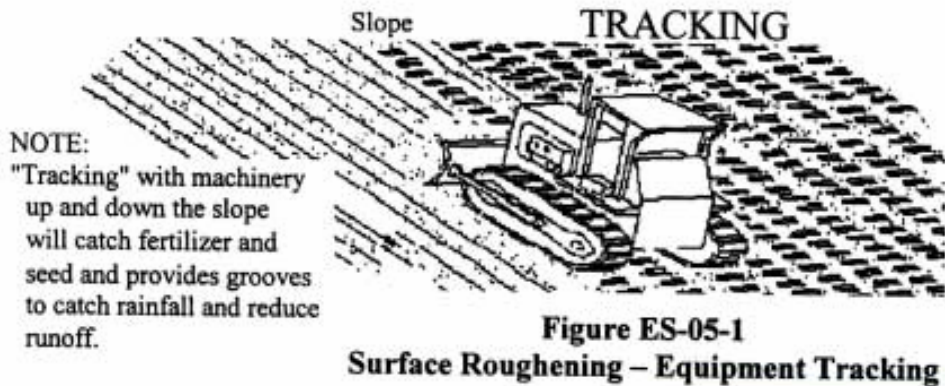

**OBJECTIVES**

- Housekeeping Practices
- Contain Waste
- Minimize Disturbed Areas
- Stabilize Disturbed Areas
- Protect Slopes/Channels
- Control Site Perimeter
- Control Internal Erosion

**TARGETED POLLUTANTS**

**H M L**

- Sediment
- Nutrients
- Heavy Metals
- Toxic Materials
- Oil & Grease
- Floatable Materials
- Bacteria & Viruses
- Other Waste

**IMPLEMENTATION REQUIREMENTS**

**H M L**

- Capital Costs
- O&M Costs
- Maintenance
- Training
- Staffing
- Administrative

**H = High M = Medium L = Low**

**DESCRIPTION:**

Rough preparation of working areas leaving depressions and uneven surface. Depressions should be done parallel to contours.

**APPLICATION:**

- Surface roughening is appropriate for all construction that will not be receiving impervious cover within 14 days and that will be exposed less than 60 days (seed areas to be open in excess of 60 days)

**INSTALLATION / APPLICATION CRITERIA:**

- Surface should be left in rough condition during initial earthwork activity
- Surfaces that have become smoothed or compacted due to equipment traffic should be roughened by use of disks, spring harrows, teeth on front end loader, or similar, operating along the contours of the slope. Tracking (by crawler tractor driving up and down slope) may also be used to provide depressions parallel to contours
- Avoid compaction of soils during roughening as this inhibits plant growth and promotes storm water runoff. Limit tracked machinery to sandy soil
- Seed or mulch areas to be exposed in excess of 60 days
- Employ dust controls (see Dust Control Detail Sheet if appropriate)

**LIMITATIONS:**

- Will not withstand heavy rainfall
- Slopes steeper than 2:1 (50%) should be benched (see Benching Detail Sheet)

**MAINTENANCE:**

- Inspect following any storm event and at a minimum of weekly
- If erosion in the form of rills (small waterways formed by runoff) is evident, perform machine roughening of area
- For vegetated slopes reseed areas that are bare or have been reworked



1500 East 650 North  
Fruit Heights, UT 84037



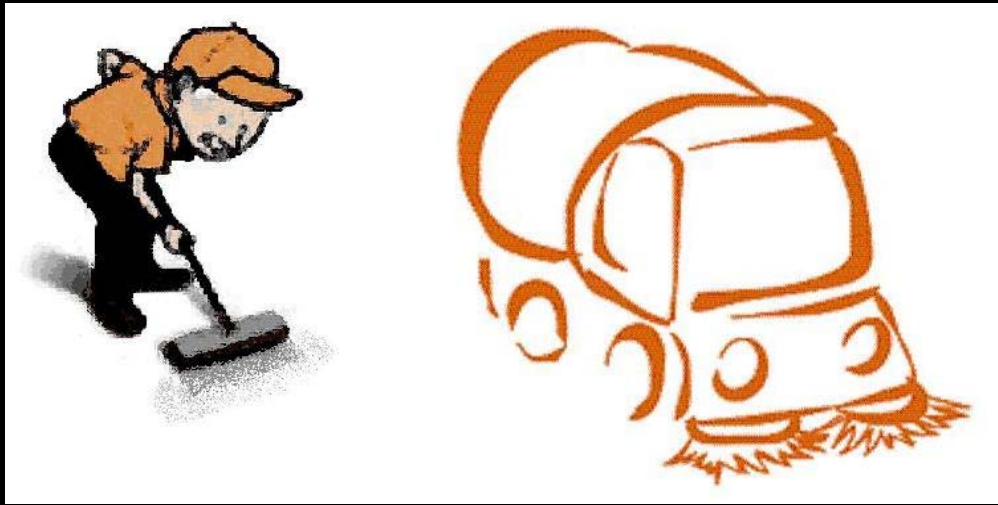

**OBJECTIVES**

- Housekeeping Practices
- Contain Waste
- Minimize Disturbed Areas
- Stabilize Disturbed Areas
- Protect Slopes/Channels
- Control Site Perimeter
- Control Internal Erosion

**TARGETED POLLUTANTS**

**H M L**

- Sediment
- Nutrients
- Heavy Metals
- Toxic Materials
- Oil & Grease
- Floatable Materials
- Bacteria & Viruses
- Other Waste

**IMPLEMENTATION REQUIREMENTS**

**H M L**

- Capital Costs
- O&M Costs
- Maintenance
- Training
- Staffing
- Administrative

**H = High M = Medium L = Low**

**DESCRIPTION:**

Prevent sediment from entering storm water by sweeping the streets near construction activities.

**APPLICATION:**

- Useful for any paved streets near construction sites where sediment is blown, tracked, or spilled onto the streets.

**INSTALLATION / APPLICATION CRITERIA:**

- The equipment used should be appropriate for the conditions. Vacuum sweepers work more effectively when the area is dry. Brush sweepers work better when the sediment is wet or stuck to the surface.
- Mechanical equipment should be operated and maintained according to the manufacturer's recommendations

**LIMITATIONS:**

- Is labor and equipment intensive
- May cause dust

**MAINTENANCE:**

- The street should be checked daily for any sediment deposits. Street sweeping should be implemented whenever sediment from construction activity is found on the streets



1500 East 650 North  
Fruit Heights, UT 84037

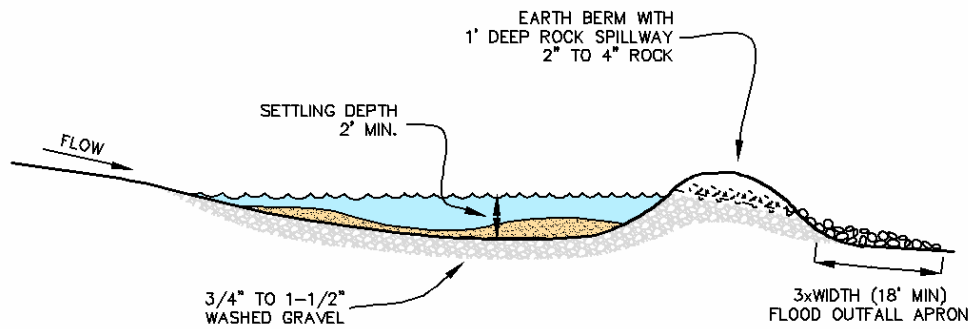

**OBJECTIVES**

- Housekeeping Practices
- Contain Waste
- Minimize Disturbed Areas
- Stabilize Disturbed Areas
- Protect Slopes/Channels
- Control Site Perimeter
- Control Internal Erosion

**TARGETED POLLUTANTS**

**H M L**

- Sediment
- Nutrients
- Heavy Metals
- Toxic Materials
- Oil & Grease
- Floatable Materials
- Bacteria & Viruses
- Other Waste

**DESCRIPTION:**

A sediment trap is a small excavated or bermed area where runoff from small drainage areas is detained and sediment can settle.

**APPLICATION:**

- Temporary control for runoff from disturbed areas of less than 3 acres
- Temporary control for discharge from diversion dike, surface benching, or other temporary drainage measures

**INSTALLATION / APPLICATION CRITERIA:**

- Design basin for site specific location
- Excavate basin or construct compacted berm containment
- Construct outfall spillway with apron
- Provide downstream silt fence if necessary

**LIMITATIONS:**

- Should be sized based on anticipated runoff, sediment loading and drainage area size
- May require silt fence at outlet for entrapment of very fine silts and calys

**MAINTENANCE:**

- Inspect after each rainfall event and at a minimum of once every two weeks
- Repair any damage to berm, spillway or sidewalls
- Remove accumulated sediment as it reaches 2/3 height of available storage
- Check outlet for sedimentation/erosion of downgradient area and remediate as necessary. Install silt fence if sedimentation apparent.

**IMPLEMENTATION REQUIREMENTS**

**H M L**

- Capital Costs
- O&M Costs
- Maintenance
- Training
- Staffing
- Administrative

**H = High M = Medium L = Low**



1500 East 650 North  
Fruit Heights, UT 84037

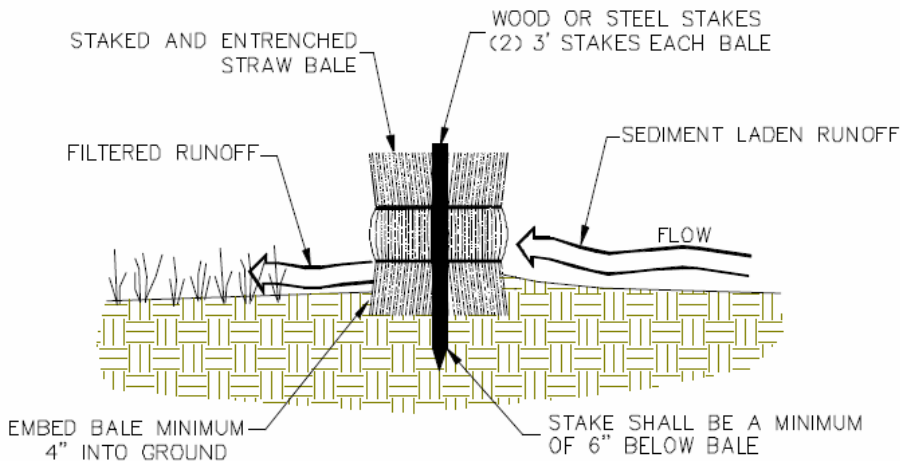

**OBJECTIVES**

- Housekeeping Practices
- Contain Waste
- Minimize Disturbed Areas
- Stabilize Disturbed Areas
- Protect Slopes/Channels
- Control Site Perimeter
- Control Internal Erosion

**TARGETED POLLUTANTS**

**H M L**

- Sediment
- Nutrients
- Heavy Metals
- Toxic Materials
- Oil & Grease
- Floatable Materials
- Bacteria & Viruses
- Other Waste

**IMPLEMENTATION REQUIREMENTS**

**H M L**

- Capital Costs
- O&M Costs
- Maintenance
- Training
- Staffing
- Administrative

**H = High M = Medium L = Low**

**DESCRIPTION:**

Temporary sediment barrier consisting of a row of entrenched and anchored straw bales.

**APPLICATION:**

- Perimeter Control: place barrier at downgradient limits of disturbance
- Sediment barrier: place barrier at toe of slope or soil stockpile
- Protection of existing waterways: place barrier at top of stream bank
- Inlet Protection

**INSTALLATION / APPLICATION CRITERIA:**

- Excavate a 4" minimum deep trench along contour line, i.e., parallel to slope, removing all grass and other material that may allow underflow
- Place bales in trench with ends tightly abutting; fill any gaps by wedging loose straw into openings
- Anchor each bale and compact to prevent piping; backfill on uphill side to be built up 4" above ground at the barrier

**LIMITATIONS:**

- Recommended maximum area of 0.5 acre per 100' of barrier
- Recommended maximum upgradient slope length of 150 feet
- Recommended maximum uphill grade of 2:1 (50%)
- Maximum duration of use is 6 months

**MAINTENANCE:**

- Inspect immediately after any rainfall and at least daily during prolonged rainfall
- Look for runoff bypassing ends of barriers or undercutting barriers
- Repair or replace damaged areas of the barrier and remove accumulated sediment
- Realign bales as necessary to provide continuous barrier and fill gaps
- Recompress soil around barrier as necessary to prevent piping



1500 East 650 North  
Fruit Heights, UT 84037

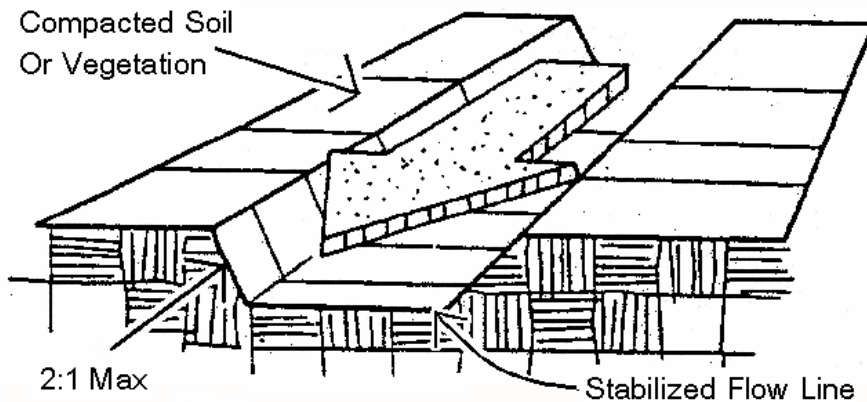

**OBJECTIVES**

- Housekeeping Practices
- Contain Waste
- Minimize Disturbed Areas
- Stabilize Disturbed Areas
- Protect Slopes/Channels
- Control Site Perimeter
- Control Internal Erosion

**TARGETED POLLUTANTS**

**H M L**

- Sediment
- Nutrients
- Heavy Metals
- Toxic Materials
- Oil & Grease
- Floatable Materials
- Bacteria & Viruses
- Other Waste

**IMPLEMENTATION REQUIREMENTS**

**H M L**

- Capital Costs
- O&M Costs
- Maintenance
- Training
- Staffing
- Administrative

**H = High M = Medium L = Low**

**DESCRIPTION:**

Temporary drains and swales are used to divert off-site runoff around the construction site, divert runoff from stabilized areas around disturbed areas.

**APPLICATION:**

- Temporary drains and swales are appropriate for diverting and upslope runoff around unstabilized or disturbed areas of the construction site
- Prevent slope failures. Prevent damage to adjacent property. Prevents erosion and transport of sediments into water ways. Increases the potential for infiltration. Diverts sediment-laden runoff into sediment basins or traps.

**INSTALLATION / APPLICATION CRITERIA:**

- Temporary drainage swales will effectively convey runoff and avoid erosion if built properly
- Size temporary drainage swales using local drainage design criteria. A permanent drainage channel must be designed by a professional engineer (see the local drainage design criteria for proper design)
- At a minimum, the drain/swale should conform to predevelopment drainage patterns and capacities
- Construct the drain/swale with an uninterrupted positive grade to a stabilized outlet. Provide erosion protection or energy dissipation measures if the flow out of the drain or swale can reach an erosive velocity

**LIMITATIONS:**

- Temporary drains and swales or any other diversion of runoff should not adversely impact upstream or downstream properties
- Temporary drains and swales must conform to local floodplain management requirements

**MAINTENANCE:**

- Inspect weekly and after each rain
- Repair any erosion immediately
- Remove sediment which builds up in the swale and restricts its flow capacity



1500 East 650 North  
Fruit Heights, UT 84037



# BMP: Temporary and Permanent Seeding

TPS



## DESCRIPTION:

Temporary seeding-establishment of short term cover by application of rapidly germinating seed mix (alternatively hydroseeding may be utilized).  
Permanent seeding-establishment of final term cover by application of perennial seed mix (alternatively sod may be utilized).

## APPLICATION:

Disturbed areas that are at final grade and which will not be disturbed by continuing activities on site. Also areas that are not at final grade but which will be left untouched in excess of one year.

## RECOMMENDED SEED MIX:

The recommended seed mix will be dependent on site specific information such as elevation, exposure, soils, water available and topography. Check with the County Extension Service for recommended mixes for site specific conditions:

Utah State University Extension Service  
28 E. State Street (Room 20D)  
Farmington, Utah 84025  
Phone: (801) 451-3412

## LIMITATIONS:

- Limited to areas that will not be subject to traffic or high usage
- May require irrigation and fertilizer which creates potential for impacting runoff quality
- May only be applied during appropriate planting season, temporary cover required until that time

## INSTALLATION:

- Roughen soil to a depth of 2 inches. Add fertilizer, manure, topsoil as necessary
- Evenly distribute seed using a commonly accepted method such as; breast seeding, drilling, hydro-seeding
- Use a seed mix appropriate for soil and location that will provide rapid germination and growth. Check with County for recommended mix and application rate.
- Cover area with mulch if required due to steep slopes or unsuitable weather conditions

## MAINTENANCE:

- Provide irrigation as required to establish growth and to maintain plant cover through duration of project
- Reseed as necessary to provide 75% coverage
- Remediate any areas damaged by erosion or traffic
- When 75% coverage is achieved inspect monthly for damage and remediate as necessary

## OBJECTIVES

- Housekeeping Practices
- Contain Waste
- Minimize Disturbed Areas
- Stabilize Disturbed Areas
- Protect Slopes/Channels
- Control Site Perimeter
- Control Internal Erosion

## TARGETED POLLUTANTS

### H M L

- Sediment
- Nutrients
- Heavy Metals
- Toxic Materials
- Oil & Grease
- Floatable Materials
- Bacteria & Viruses
- Other Waste

## IMPLEMENTATION REQUIREMENTS

### H M L

- Capital Costs
- O&M Costs
- Maintenance
- Training
- Staffing
- Administrative

H = High M = Medium L = Low



1500 East 650 North  
Fruit Heights, UT 84037

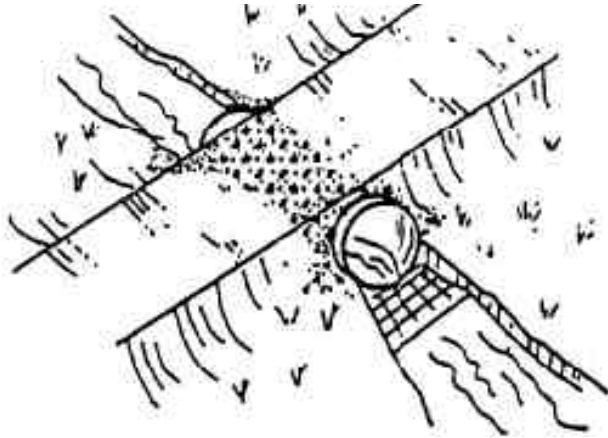

**DESCRIPTION:**

A temporary access stream crossing is a temporary culvert, ford or bridge placed across a waterway to provide access for construction purposes for a period of less than one year. Temporary access crossings are not intended to be used to maintain traffic for the general public.

**APPLICATION:**

- Temporary stream crossings should be installed at all designated crossings of perennial and intermittent streams on the construction site, as well as for dry channels which may be significantly eroded by construction traffic.

**INSTALLATION / APPLICATION CRITERIA:**

- Requires knowledge of stream flows and soil strength and should be designed under the direction of a Utah registered engineer with knowledge of both hydraulics and construction loading requirements for structures.

**LIMITATIONS:**

- May be expensive for a temporary improvement
- Requires other BMP's to minimize soil disturbance during installation and removal
- Fords should only be used in dry weather
- A Stream Alteration Permit may be required, contact the Utah Division of Water Rights before implementation

**MAINTENANCE:**

- Inspect weekly and after each significant rainfall, including assessment of foundations
- Periodically remove silt from crossings
- Replace lost aggregate from inlets and outlets of culverts

**OBJECTIVES**

- Housekeeping Practices
- Contain Waste
- Minimize Disturbed Areas
- Stabilize Disturbed Areas
- Protect Slopes/Channels
- Control Site Perimeter
- Control Internal Erosion

**TARGETED POLLUTANTS**

**H M L**

- Sediment
- Nutrients
- Heavy Metals
- Toxic Materials
- Oil & Grease
- Floatable Materials
- Bacteria & Viruses
- Other Waste

**IMPLEMENTATION REQUIREMENTS**

**H M L**

- Capital Costs
- O&M Costs
- Maintenance
- Training
- Staffing
- Administrative

**H = High M = Medium L = Low**



1500 East 650 North  
Fruit Heights, UT 84037



**OBJECTIVES**

- Housekeeping Practices
- Contain Waste
- Minimize Disturbed Areas
- Stabilize Disturbed Areas
- Protect Slopes/Channels
- Control Site Perimeter
- Control Internal Erosion

**TARGETED POLLUTANTS**

**H M L**

- Sediment
- Nutrients
- Heavy Metals
- Toxic Materials
- Oil & Grease
- Floatable Materials
- Bacteria & Viruses
- Other Waste

**IMPLEMENTATION REQUIREMENTS**

**H M L**

- Capital Costs
- O&M Costs
- Maintenance
- Training
- Staffing
- Administrative

**H = High M = Medium L = Low**

**DESCRIPTION:**

Prevent or reduce the discharge of pollutants to storm water from vehicle and equipment cleaning by using off-site facilities, washing in designated, contained areas only, eliminating discharges to the storm drain by infiltrating or recycling the wash water, and/or training employees and subcontractors.

**INSTALLATION / APPLICATION CRITERIA:**

- Use off-site commercial washing businesses as much as possible. Washing vehicles and equipment outdoors or in areas where wash water flows onto paved surfaces or into drainage pathways can pollute storm water. If you wash large number of vehicles or pieces of equipment, consider conducting this work at an off-site commercial business. These businesses are better equipped to handle and dispose of the wash waters properly. Performing this work off-site can also be economical by eliminating the need for a separate washing operation at your site.
- If washing must occur on-site, use designated, bermed wash areas to prevent wash water contact with storm water, creeks, rivers, and other water bodies. The wash area can be sloped for wash water collection and subsequent infiltration into the ground.
- Use as little water as possible to avoid having to install erosion and sediment controls for the wash area. Use phosphate-free biodegradable soaps. Educate employees and subcontractors on pollution prevention measures. Do not permit steam cleaning on-site. Steam cleaning can generate significant pollutant concentrations.

**LIMITATIONS:**

- Even phosphate-free, biodegradable soaps have been shown to be toxic to fish before the soap degrades
- Sending vehicles/equipment off-site should be done in conjunction with Stabilized Construction Entrance

**MAINTENANCE:**

- Minimal, some berm repair may be necessary



1500 East 650 North  
Fruit Heights, UT 84037

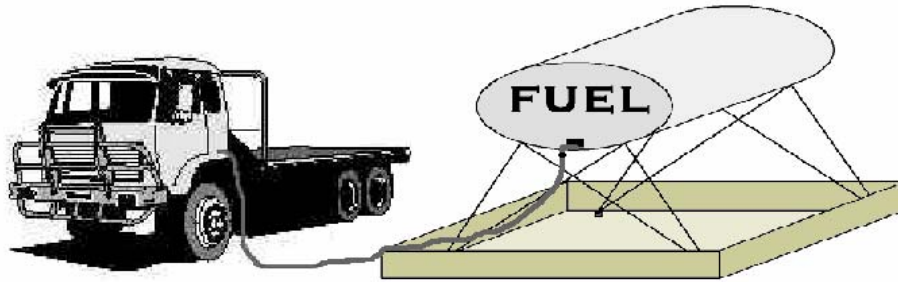

**OBJECTIVES**

- Housekeeping Practices
- Contain Waste
- Minimize Disturbed Areas
- Stabilize Disturbed Areas
- Protect Slopes/Channels
- Control Site Perimeter
- Control Internal Erosion

**TARGETED POLLUTANTS**

**H M L**

- Sediment
- Nutrients
- Heavy Metals
- Toxic Materials
- Oil & Grease
- Floatable Materials
- Bacteria & Viruses
- Other Waste

**IMPLEMENTATION REQUIREMENTS**

**H M L**

- Capital Costs
- O&M Costs
- Maintenance
- Training
- Staffing
- Administrative

**H = High M = Medium L = Low**

**DESCRIPTION:**

Prevent fuel spills and leaks, and reduce their impacts to storm water by using offsite facilities, fueling in designated areas only, enclosing or covering stored fuel, implementing spill controls, and training employees and subcontractors.

**INSTALLATION / APPLICATION CRITERIA:**

- Use off-site fueling stations as much as possible. Fueling vehicles and equipment outdoors or in areas where fuel may spill/leak onto paved surfaces or into drainage pathways can pollute storm water. If you fuel a large number of vehicles or pieces of equipment, consider using an off-site fueling station. These businesses are better equipped to handle fuel and spills properly. Performing this work off-site can also be economical by eliminating the need for a separate fueling area at your site.
- If fueling must occur on-site, use designated areas, located away from drainage courses, to prevent the run on of storm water and the runoff of spills. Discourage "topping-off" of fuel tanks.
- Always use secondary containment, such as a drain pan or drop cloth, when fueling to catch spills/leaks. Place a stockpile of spill cleanup materials where it will be readily accessible. Use adsorbent materials on small spills rather than hosing down or burying the spill. Remove the adsorbent materials promptly and dispose of properly.
- Carry out all Federal and State requirements regarding stationary above ground storage tanks.(40 CF Sub. J) Avoid mobile fueling of mobile construction equipment around the site; rather, transport the equipment to designated fueling areas. With the exception of tracked equipment such as bulldozers and perhaps forklifts, most vehicles should be able to travel to a designated area with little lost time. Train employees and subcontractors in proper fueling and cleanup procedures.

**LIMITATIONS:**

Sending vehicles/equipment off-site should be done in conjunction with Stabilized Construction Entrance

**MAINTENANCE:**

- Keep ample supplies of spill cleanup materials on-site
- Inspect fueling areas and storage tanks on a regular schedule



1500 East 650 North  
Fruit Heights, UT 84037



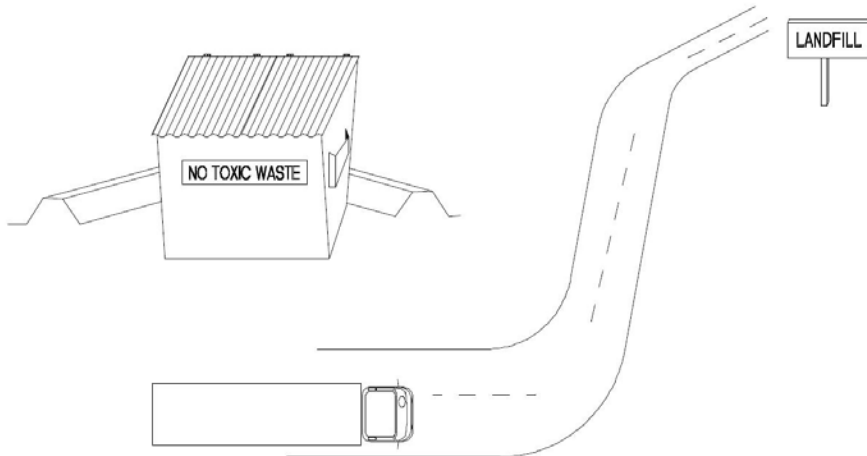

**OBJECTIVES**

- Housekeeping Practices
- Contain Waste
- Minimize Disturbed Areas
- Stabilize Disturbed Areas
- Protect Slopes/Channels
- Control Site Perimeter
- Control Internal Erosion

**TARGETED POLLUTANTS**

**H M L**

- Sediment
- Nutrients
- Heavy Metals
- Toxic Materials
- Oil & Grease
- Floatable Materials
- Bacteria & Viruses
- Other Waste

**IMPLEMENTATION REQUIREMENTS**

**H M L**

- Capital Costs
- O&M Costs
- Maintenance
- Training
- Staffing
- Administrative

**H = High M = Medium L = Low**

**DESCRIPTION:**

Controlled storage and disposal of solid waste generated by construction activities.

**APPLICATION:**

All construction sites

**INSTALLATION / APPLICATION CRITERIA:**

- Designate one or several waste collection areas with easy access for construction vehicles and personnel. Ensure no waterways or storm drainage inlets are located near the waste collection areas.
- Construct compacted earthen berm (See Earth Berm Barrier Information Sheet), or similar perimeter containment around collection area for impoundment in the case of spills.
- Ensure all on site personnel are aware of and utilize designated waste collection area properly and for intended use only (e.g. all toxic, hazardous, or recyclable materials shall be properly disposed of separately from general construction waste).
- Arrange for periodic pickup, transfer and disposal of collected waste at an authorized disposal location. Include regular Porto-potty service in waste management activities.

**LIMITATIONS:**

- On-site personnel are responsible for correct disposal of waste

**MAINTENANCE:**

- Discuss waste management procedures at progress meetings
- Collect site trash daily and deposit in containers at designated collection areas
- Randomly check disposed materials for any unauthorized waste (e.g. toxic materials).



1500 East 650 North  
Fruit Heights, UT 84037

**STORMWATER RESOURCES**

Environmental Protection Agency (EPA) Region VIII ..... (800) 227-8917

Army Corps of Engineers ..... (801) 295-8380

Utah Department of Environmental Quality

    Division of Water Quality..... 538-6146

    Division of Environmental Response and Remediation ..... 536-4100

    Division of Air Quality ..... 536-4000

    Solid and Hazardous Waste - Used Oil Hotline..... (800) 458-0145

Utah Division of Natural Resources

    General Information..... 539-4001

Davis County Health Department

    Water Quality and Hazardous Waste

    Environmental Health

Davis County Public Works Engineering

Bountiful City

Centerville City

Clinton City

Farmington City

Fruit Heights City

Kaysville City

Layton City

North Salt Lake City

South Weber City

Sunset City

West Bountiful City

West Point City

Woods Cross City